

Smart Agriculture Xtreme 1.0

Technical Guide



Document version: v.7.1 - 07/2018
© Libelium Comunicaciones Distribuidas S.L.

INDEX

1. General and safety information	6
2. Important: Read before use	7
3. Waspote Plug & Sense!.....	8
3.1. Features	8
3.2. General view	9
3.3. Specifications	9
3.4. Parts included.....	12
3.5. Identification.....	13
3.6. Sensor probes.....	15
3.7. Solar powered	16
3.8. External Battery Module.....	18
3.9. Programming the Nodes.....	19
3.10. Program in minutes	20
3.11. Radio interfaces.....	21
3.12. Industrial Protocols.....	22
3.13. GPS.....	24
3.14. Models	25
4.1. General comments	29
4.2. Non-contact surface temperature measurement sensor probe (Apogee SI-411).....	30
4.2.1. Specifications.....	30
4.2.2. Measurement process	31
4.2.3. Socket	31
4.2.4. Installation	32
4.2.5. Application examples.....	33
4.2.6. Certificate of calibration	33
4.3. Leaf and flower bud temperature sensor probe (Apogee SF-421)	34
4.3.1. Specifications.....	34
4.3.2. Measurement process	35
4.3.3. Socket.....	35
4.3.4. Installation	36
4.3.5. Application examples.....	37
4.3.6. Quality Assurance Certificate.....	37
4.4. Soil oxygen level sensor probe (Apogee SO-411).....	38
4.4.1. Specifications.....	39
4.4.2. Measurement process	39
4.4.3. Socket.....	40
4.4.4. Installation	41
4.4.5. Application examples.....	42

4.4.6. Quality Assurance Certificate.....	42
4.5. Shortwave radiation sensor probe (Apogee SP-510).....	43
4.5.1. Specifications.....	43
4.5.2. Measurement process	44
4.5.3. Socket	44
4.5.4. Installation	45
4.5.5. Application examples.....	47
4.5.6. Certificate of calibration	47
4.6. Solar radiation sensor probe for Smart Agriculture Xtreme (Apogee SQ-110)	48
4.6.1. Specifications.....	49
4.6.2. Measurement process	49
4.6.3. Socket	50
4.6.4. Installation	50
4.6.5. Application examples.....	52
4.6.6. Certificate of calibration	52
4.7. Ultraviolet radiation sensor probe for Smart Agriculture Xtreme (Apogee SU-100).....	53
4.7.1. Specifications.....	54
4.7.2. Measurement process	54
4.7.3. Socket	55
4.7.4. Installation	55
4.7.5. Application examples.....	57
4.7.6. Certificate of calibration	57
4.8. Temperature, humidity and pressure sensor probe (Bosch BME280)	58
4.8.1. Specifications.....	58
4.8.2. Measurement process	59
4.8.3. Socket	59
4.8.4. Application examples.....	60
4.9. Conductivity, water content and soil temperature GS3 sensor probe (Decagon GS3)	61
4.9.1. Specifications.....	62
4.9.2. Measurement process	62
4.9.3. Socket	63
4.9.4. Installation	63
4.9.5. Application examples.....	65
4.9.6. Quality Assurance Certificate.....	65
4.10. Conductivity, water content and soil temperature 5TE sensor probe (Decagon 5TE)	66
4.10.1. Specifications	67
4.10.2. Measurement process.....	67
4.10.3. Socket	68
4.10.4. Installation.....	69
4.10.5. Application examples.....	69
4.10.6. Quality Assurance Certificate	69
4.11. Soil temperature and volumetric water content sensor probe (Decagon 5TM)	70
4.11.1. Specifications	71
4.11.2. Measurement process.....	71
4.11.3. Socket	72

4.11.4. Installation.....	72
4.11.5. Application examples.....	73
4.11.6. Quality Assurance Certificate	73
4.12. Soil water potential sensor probe (Decagon MPS-6).....	74
4.12.1. Specifications	75
4.12.2. Measurement process.....	75
4.12.3. Socket	76
4.12.4. Installation.....	76
4.12.5. Application examples.....	77
4.12.6. Quality Assurance Certificate	77
4.13. Vapor pressure, temperature, barometric pressure and relative humidity sensor (Decagon VP-4)	78
4.13.1. Specifications	79
4.13.2. Measurement process.....	81
4.13.3. Socket	82
4.13.4. Installation.....	82
4.13.5. Application examples.....	83
4.13.6. Quality Assurance Certificate	83
4.14. Leaf wetness Phytos 31 sensor probe (Decagon Phytos 31)	84
4.14.1. Specifications	85
4.14.2. Measurement process.....	85
4.14.3. Socket	85
4.14.4. Installation.....	86
4.14.5. Application examples.....	86
4.14.6. Quality Assurance Certificate	86
4.15. Dendrometer sensor probes for Smart Agriculture Xtreme (Ecomatik DC2, DD-S and DF).....	87
4.15.1. Ecomatik DC2 specifications (Trunk diameter)	87
4.15.2. Ecomatik DD-S specifications (Stem diameter)	88
4.15.3. Ecomatik DF specifications (Fruit diameter)	88
4.15.4. Measurement process.....	88
4.15.5. Socket	89
4.15.6. Installation.....	90
4.15.7. Application examples.....	90
4.16. Weather station sensor probes (Gill Instruments MaxiMet series)	91
4.16.1. MaxiMet GMX-100 (PO) sensor probe	92
4.16.2. MaxiMet GMX-101 (R) sensor probe	92
4.16.3. MaxiMet GMX-200 (W) sensor probe	93
4.16.4. MaxiMet GMX-240 (W-PO) sensor probe	94
4.16.5. MaxiMet GMX-300 (T-H-AP) sensor probe.....	95
4.16.6. MaxiMet GMX-301 (T-H-AP-R) sensor probe.....	95
4.16.7. MaxiMet GMX-400 (PO-T-H-AP) sensor probe.....	96
4.16.8. MaxiMet GMX-500 (W-T-H-AP) sensor probe.....	97
4.16.9. MaxiMet GMX-501 (W-T-H-AP-R) sensor probe.....	98
4.16.10. MaxiMet GMX-531 (W-PT-T-H-AP-R) sensor probe.....	99
4.16.11. MaxiMet GMX-541 (W-PO-T-H-AP-R) sensor probe.....	100
4.16.12. MaxiMet GMX-550 (W-x-T-H-AP) sensor probe	101

4.16.13. MaxiMet GMX-551 (W-x-T-H-AP-R) sensor probe	102
4.16.14. MaxiMet GMX-600 (W-PO-T-H-AP) sensor probe	103
4.16.15. Specifications for each weather station sensor	104
4.16.16. Measurement process	105
4.16.17. Socket	106
4.16.18. Installation	106
4.16.20. Product test report	109
4.17. Luminosity sensor (AMS TSL2561).....	110
4.17.1. Specifications	110
4.17.2. Measurement process.....	111
4.17.3. Socket	111
4.17.4. Application examples.....	111
4.18. Ultrasound sensor probe (Maxbotix MB7040).....	112
4.18.1. Specifications	112
4.18.2. Measurement process.....	113
4.18.3. Socket	113
4.18.4. Installation.....	114
4.18.5. Application examples.....	114
5. Board configuration and programming	115
5.1. Hardware configuration	115
5.2. API.....	115
5.2.1. Before starting to program	115
5.2.2. Sending sensor values with the Frame class	116
6. Consumption	117
6.1. Consumption table.....	117
7. API changelog	118
8. Documentation changelog	119
9. Certifications.....	120
10. Maintenance	121
11. Disposal and recycling	122

1. General and safety information

Important:

- All documents and any examples they contain are provided as-is and are subject to change without notice. Except to the extent prohibited by law, Libelium makes no express or implied representation or warranty of any kind with regard to the documents, and specifically disclaims the implied warranties and conditions of merchantability and fitness for a particular purpose.
- The information on Libelium's websites has been included in good faith for general informational purposes only. It should not be relied upon for any specific purpose and no representation or warranty is given as to its accuracy or completeness.
- Read carefully Limited Warranty and Terms and Conditions of Use before using "Waspote Plug & Sense!".
- Do not open casing and do not damage black warranty stickers. If you do so, you will lose warranty.
- Do not remove any of the connectors.
- Do not allow contact between metallic objects and electronic parts to avoid injury and burns.
- Never immerse equipment in any liquid.
- Keep equipment within temperature range indicated in recommendation section.
- Do not connect or power equipment using cables that have been damaged.
- Place equipment in an area to which only maintenance personnel can have access (in a restricted access zone).
- In any case keep children away from the equipment.
- If there is a power failure, immediately disconnect from the mains.
- If using a battery whether or not in combination with a solar panel as a power source follow the voltage and current specifications indicated in the section "External solar panel connector".
- If a software failure occurs, contact Libelium technical support before doing any action by yourself.
- Do not place equipment on trees or plants as they could be damaged by its weight.
- Be particularly careful if you are connected through a software interface for handling the machine; if settings of that interface are incorrectly altered, it could become inaccessible.
- If you need to clean the node, wipe it with a dry towel.
- If Waspote Plug & Sense! needs to be returned please send it completely dry and free from contaminants.
- Waspote Plug & Sense! is not designed to be placed in hard environmental conditions, under dangerous chemical elements, explosive atmospheres with flammable gases, high voltage installations or special installations. Please contact Libelium technical support to ensure your application is compatible with Waspote Plug & Sense!

2. Important: Read before use

The following list shows just some of the actions that produce the most common failures and warranty-voiding. Complete documentation about usage can be found at <http://www.libelium.com/development>. Failure to comply with the recommendations of use will entail the warranty cancellation.

Software:

- Upload code only using WaspMote IDE. If a different IDE is used, WaspMote can be damaged and can become unresponsive. This use is not covered under warranty.
- Do not unplug any connector while uploading code. WaspMote can become unresponsive. This use is not covered under warranty.
- Do not connect or disconnect any connector while WaspMote is on. WaspMote can become unstable or unresponsive, and internal parts can be damaged. This fact is not covered under warranty.

Hardware:

- Do not handle black stickers seals on both sides of the enclosure (Warranty stickers). Their integrity is the proof that WaspMote Plug & Sense! has not been opened. If they have been handled, damaged or broken, the warranty is void.
- Do not open WaspMote Plug & Sense! in any case. This will automatically make the warranty void.
- Do not handle the four metallic screws of WaspMote Plug & Sense!. They ensure waterproof seal.
- Do not submerge WaspMote Plug & Sense! in liquids.
- Do not place nodes on places or equipment where it could be exposed to shocks and/or big vibrations.
- Do not expose WaspMote Plug & Sense! to temperatures below -20 °C or above 60 °C.
- Do not power WaspMote with other power sources than the original provided by Libelium. Voltage and current maximum ratings can be exceeded, stopping WaspMote working and voiding warranty.
- Do not try to extract, screw, break or move WaspMote Plug & Sense! connectors far from necessary usage, waterproof sealing can be damaged and warranty will be voided.
- For more information: <http://www.libelium.com>
- Do not connect any sensor on the solar panel connector and also do not connect the solar panel to any of sensor connectors. WaspMote can be damaged and warranty void.
- Do not connect any sensor not provided by Libelium.
- Do not place WaspMote Plug & Sense! where water can reach internal parts of sensors.
- Do not get the magnet close to a metal object. The magnet is really powerful and will get stuck.
- Do not place the magnet close to electronic devices, like PCs, batteries, etc, they could be damaged, or information could be deleted.

3. Waspote Plug & Sense!

The Waspote Plug & Sense! line allows you to easily deploy Internet of Things networks in an easy and scalable way, ensuring minimum maintenance costs. The platform consists of a robust waterproof enclosure with specific external sockets to connect the sensors, the solar panel, the antenna and even the USB cable in order to reprogram the node. It has been specially designed to be scalable, easy to deploy and maintain.

Note: For a complete reference guide download the “Waspote Plug & Sense! Technical Guide” in the [Development section](#) of the [Libelium website](#).

3.1. Features

- Robust waterproof IP65 enclosure
- Add or change a sensor probe in seconds
- Solar powered with internal and external panel options
- Radios available: 802.15.4, 868 MHz, 900 MHz, WiFi, 4G, Sigfox and LoRaWAN
- Over the air programming (OTAP) of multiple nodes at once (via WiFi or 4G radios)
- Special holders and brackets ready for installation in street lights and building fronts
- Graphical and intuitive interface Programming Cloud Service
- Built-in, 3-axes accelerometer
- External, contactless reset with magnet
- Optional industrial protocols: RS-232, RS-485, Modbus, CAN Bus
- Optional GPS receiver
- Optional External Battery Module
- External SIM connector for the 4G models
- Fully certified: CE (Europe), FCC (USA), IC (Canada), ANATEL (Brazil), RCM (Australia), PTCRB (USA, cellular connectivity), AT&T (USA, cellular connectivity)



Figure: Waspote Plug & Sense!

3.2. General view

This section shows main parts of Waspote Plug & Sense! and a brief description of each one. In later sections all parts will be described deeply.

3.3. Specifications

- **Material:** polycarbonate
- **Sealing:** polyurethane
- **Cover screws:** stainless steel
- **Ingress protection:** IP65
- **Impact resistance:** IK08
- **Rated insulation voltage AC:** 690 V
- **Rated insulation voltage DC:** 1000 V
- **Heavy metals-free:** Yes
- **Weatherproof:** true - nach UL 746 C
- **Ambient temperature (min.):** -30 °C*
- **Ambient temperature (max.):** 70 °C*
- **Approximated weight:** 800 g

* Temporary extreme temperatures are supported. Regular recommended usage: -20, +60 °C.

In the pictures included below it is shown a general view of Waspote Plug & Sense! main parts. Some elements are dedicated to node control, others are designated to sensor connection and other parts are just identification elements. All of them will be described along this guide.

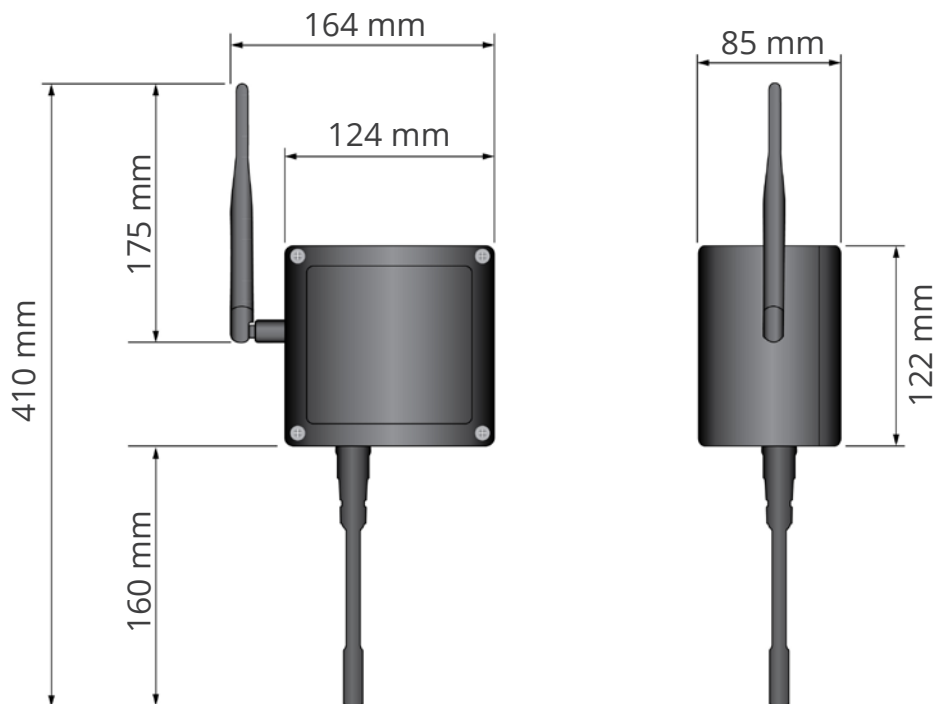

Figure: Main view of Waspote Plug & Sense!

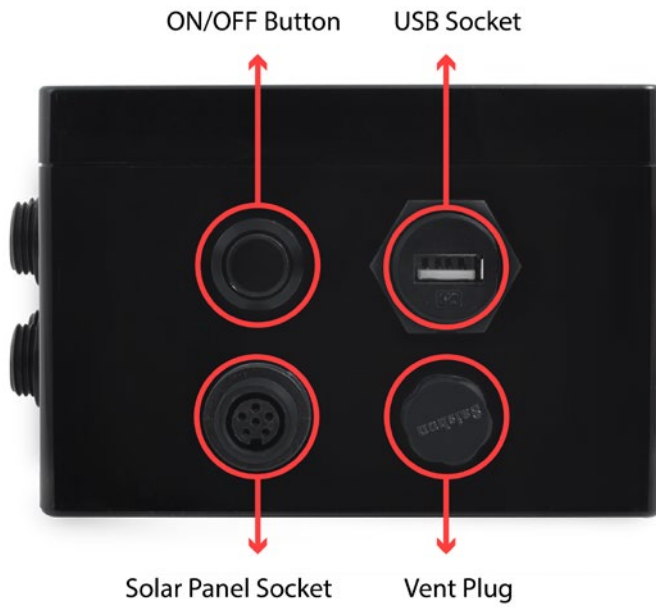

Figure: Control side of the enclosure

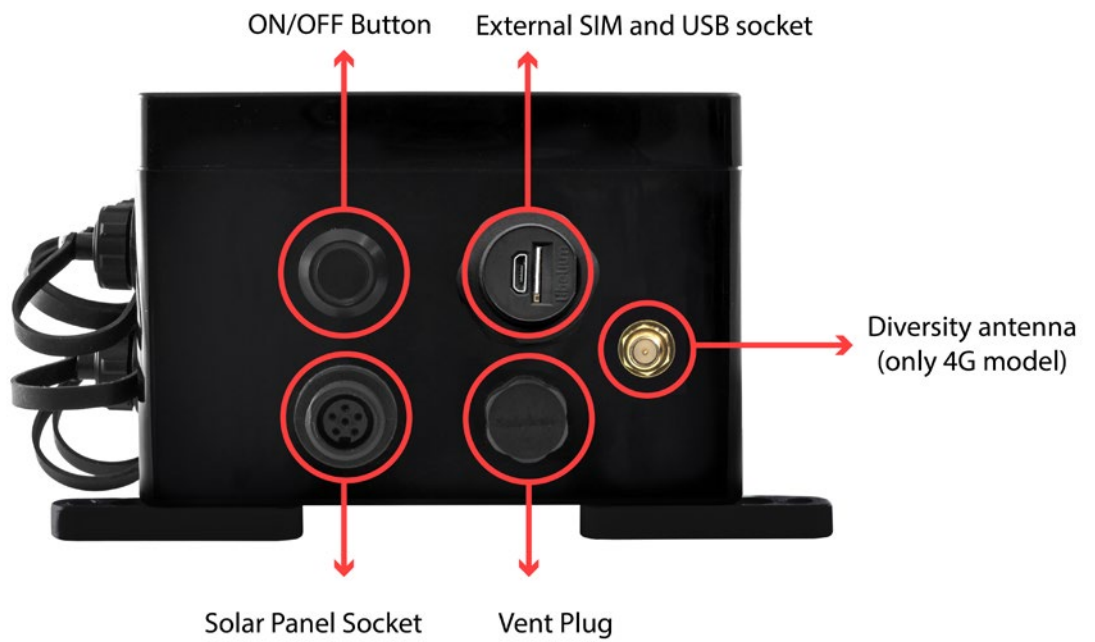

Figure: Control side of the enclosure for 4G model



Figure: Sensor side of the enclosure

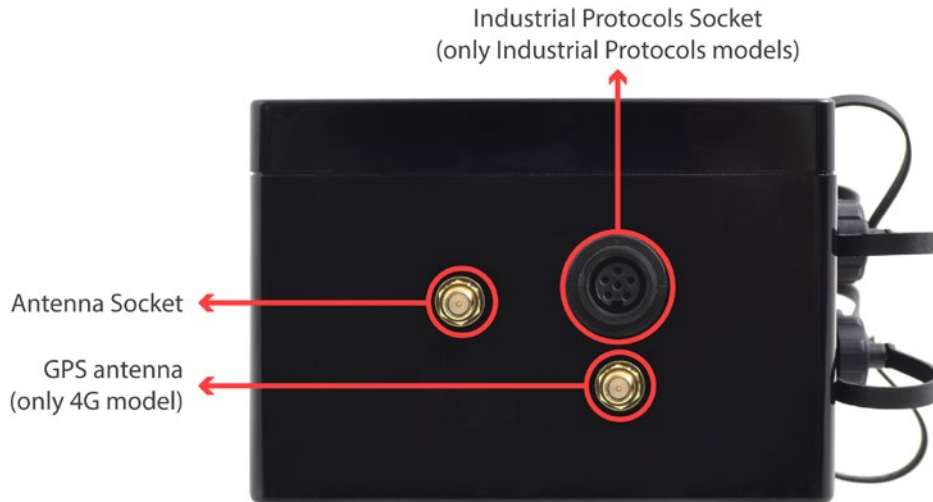

Figure: Antenna side of the enclosure



Figure: Front view of the enclosure



Figure: Back view of the enclosure



Figure: Warranty stickers of the enclosure

Important note: Do not handle black stickers seals of the enclosure (Warranty stickers). Their integrity is the proof that Wasmote Plug & Sense! has not been opened. If they have been handled, damaged or broken, the warranty is automatically void.

3.4. Parts included

Next picture shows Wasmote Plug & Sense! and all of its elements. Some of them are optional accessories that may not be included.



Figure: Wasmote Plug & Sense! accessories: 1 enclosure, 2 sensor probes, 3 external solar panel, 4 USB cable, 5 antenna, 6 cable ties, 7 mounting feet (screwed to the enclosure), 8 extension cord, 9 solar panel cable, 10 wall plugs & screws

3.5. Identification

Each Waspote model is identified by stickers. Next figure shows front sticker.

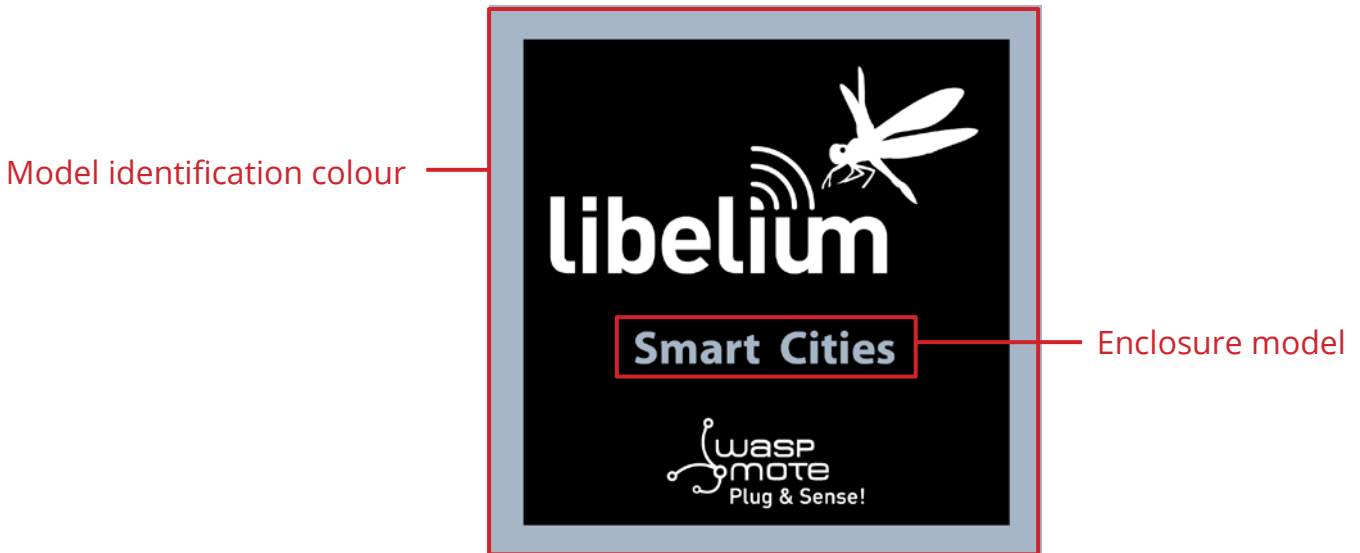

Figure: Front sticker of the enclosure

There are many configurations of Waspote Plug & Sense! line, all of them identified by one unique sticker. Next image shows all possibilities.



Figure: Different front stickers

Moreover, Waspote Plug & Sense! includes a back sticker where it is shown identification numbers, radio MAC addresses, etc. It is highly recommended to annotate this information and save it for future maintenance. Next figure shows it in detail.





	Brand name: Libelium	Country of origin: Spain
Plug & Sense! model	Model: Waspote Plug & Sense! WiFi	Version: 1.0
Device serial number	Serial ID: xxxxxxxxx	
Battery type	Battery: 6600 mA·h rechargeable	
Radio type	Radio: WiFi	
Sensor board and extra info	Info: Smart Environment	
	FCC ID: XKM-WPS-WIFI-V1	
	IC: 8472A-WPSWIFIV1	
	<p>This device complies with Part 15 of the FCC Rules. Operation is subject to the following two conditions: (1) this device may not cause harmful interference, and (2) this device must accept any interference received, including interference that may cause undesired operation.</p> <p>Este equipamento opera em caráter secundário, isto é, não tem direito a proteção contra interferência prejudicial, mesmo de estações do mesmo tipo, e não pode causar interferência a sistemas operando em caráter primário.</p>	
Certifications info		

Figure: Back sticker

Sensor probes are identified too by a sticker showing the measured parameter and the sensor manufacturer reference.



Figure: Sensor probe identification sticker

3.6. Sensor probes

Sensor probes can be easily attached by just screwing them into the bottom sockets. This allows you to add new sensing capabilities to existing networks just in minutes. In the same way, sensor probes may be easily replaced in order to ensure the lowest maintenance cost of the sensor network.



Figure: Connecting a sensor probe to Waspote Plug & Sense!

Go to the [Plug & Sense! Sensor Guide](#) to know more about our sensor probes.

3.7. Solar powered

The battery can be recharged using the waterproof USB cable but also the internal or external solar panel options.

The external solar panel is mounted on a 45° holder which ensures the maximum performance of each outdoor installation.



Figure: Waspote Plug & Sense! powered by an external solar panel

For the internal option, the solar panel is embedded on the front of the enclosure, perfect for use where space is a major challenge.



Figure: Internal solar panel



Figure: Waspote Plug & Sense! powered by an internal solar panel

3.8. External Battery Module

The External Battery Module (EBM) is an accessory to extend the battery life of Plug & Sense!. The extension period may be from months to years depending on the sleep cycle and radio activity. The daily charging period is selectable among 5, 15 and 30 minutes with a selector switch and it can be combined with a solar panel to extend even more the node's battery lifetime.

Note: Nodes using solar panel can keep using it through the External Battery Module (EBM). The EBM is connected to the solar panel connector of Plug & Sense! and the solar panel unit is connected to the solar panel connector of the EBM.

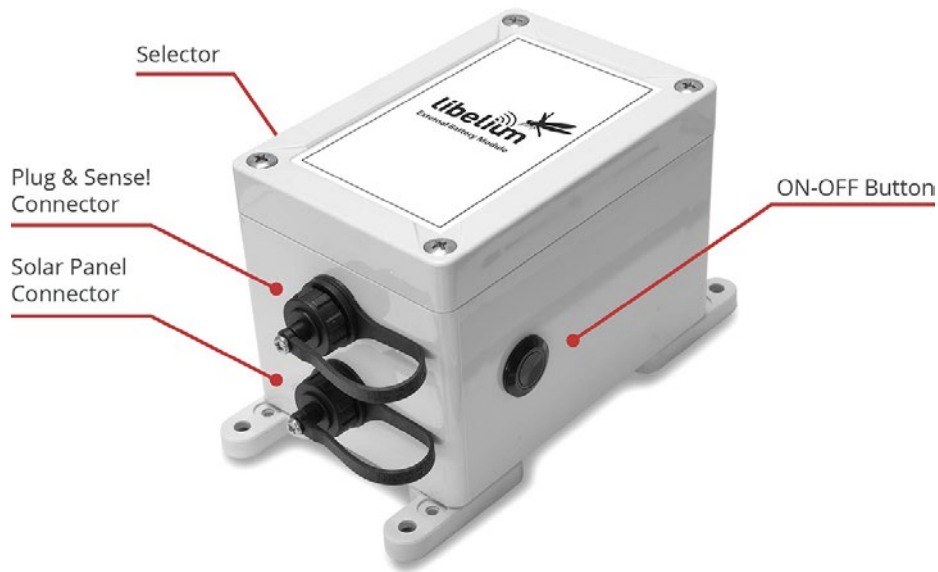

Figure: Plug & Sense! with External Battery Module



Figure: Plug & Sense! with External Battery Module and solar panel

3.9. Programming the Nodes

Waspote Plug & Sense! can be reprogrammed in two ways:

The basic programming is done from the USB port. Just connect the USB to the specific external socket and then to the computer to upload the new firmware.

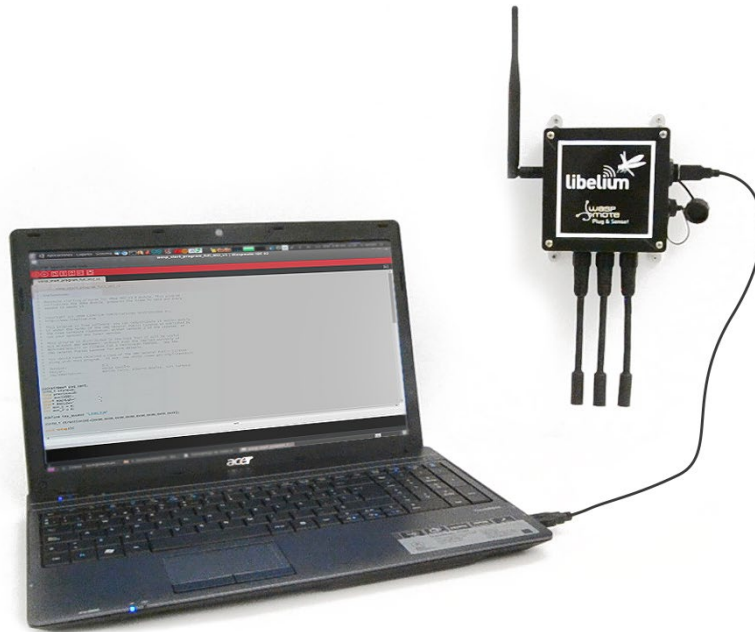

Figure: Programming a node

Over the Air Programming (OTAP) is also possible once the node has been installed (via WiFi or 4G radios). With this technique you can reprogram, wireless, one or more Waspote sensor nodes at the same time by using a laptop and Meshlium.

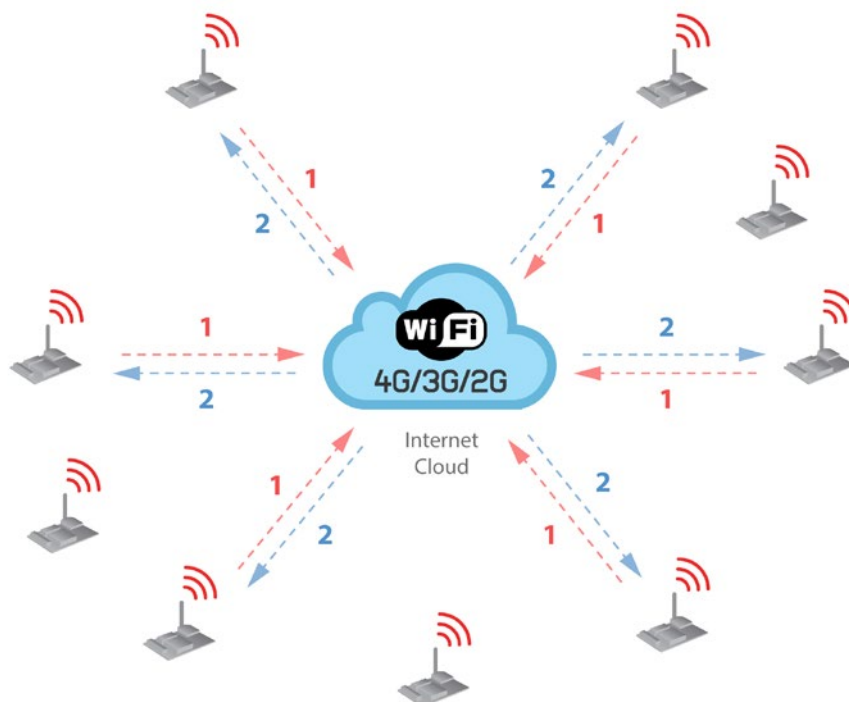

Figure: Typical OTAP process

3.10. Program in minutes

The Programming Cloud Service is an intuitive graphic interface which creates code automatically. The user just needs to fill a web form to obtain binaries for Plug & Sense!. Advanced programming options are available, depending on the license selected.

Check how easy it is to handle the Programming Cloud Service at:

<https://cloud.libelium.com/>

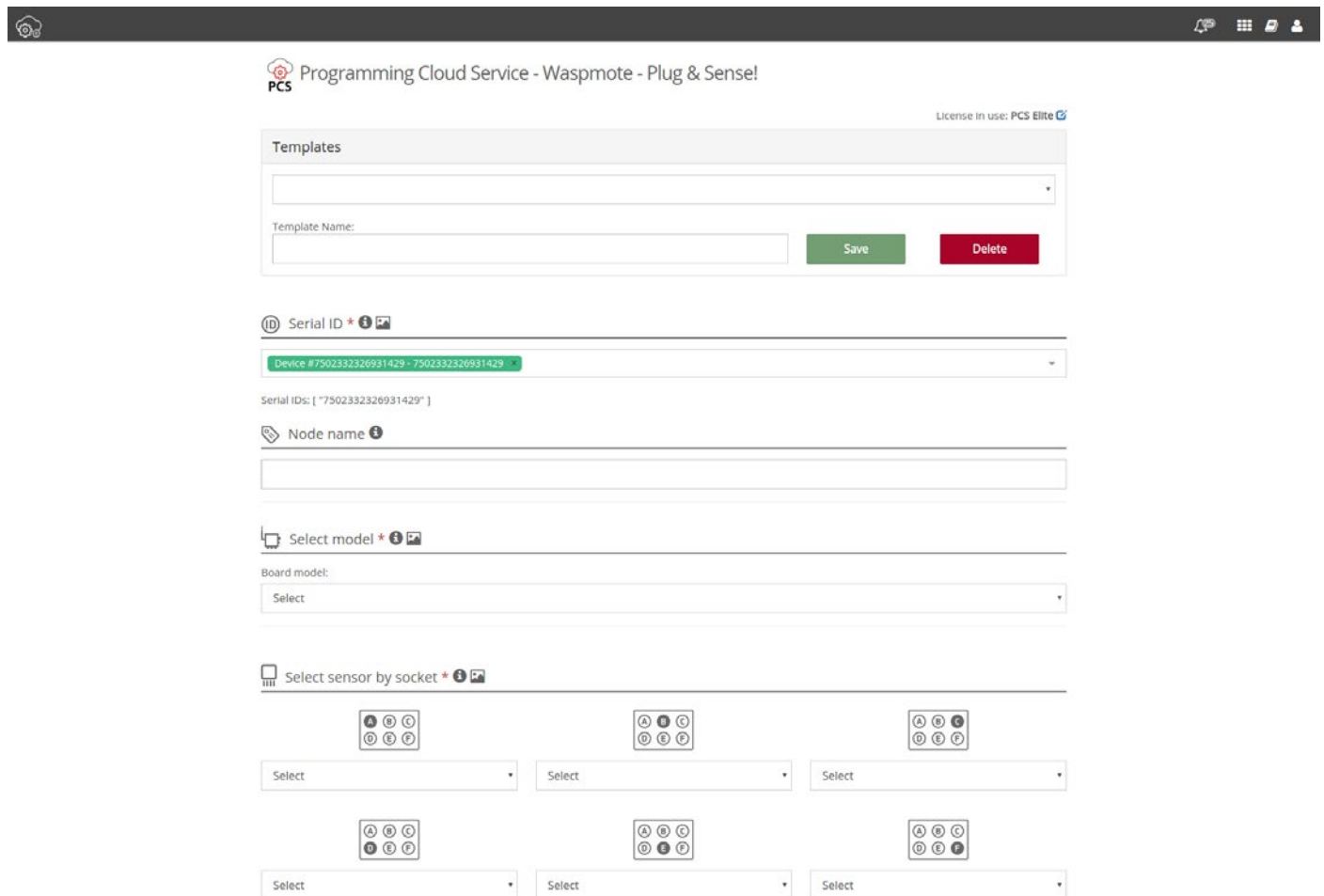

PCS Programming Cloud Service - Wasp mote - Plug & Sense! License in use: PCS Elite

Templates

Template Name:

Save Delete

Serial ID * ⓘ

Device #7502332326931429 - 7502332326931429

Serial IDs: ["7502332326931429"]

Node name ⓘ

Select model * ⓘ

Board model:

Select

Select sensor by socket * ⓘ

Select Select Select

Select Select Select

Figure: Programming Cloud Service

3.11. Radio interfaces

Radio	Protocol	Frequency bands	Transmission power	Sensitivity	Range*	Certification
XBee-PRO 802.15.4 EU	802.15.4	2.4 GHz	10 dBm	-100 dBm	750 m	CE
XBee-PRO 802.15.4	802.15.4	2.4 GHz	18 dBm	-100 dBm	1600 m	FCC, IC, ANATEL, RCM
XBee 868LP	RF	868 MHz	14 dBm	-106 dBm	8.4 km	CE
XBee 900HP US	RF	900 MHz	24 dBm	-110 dBm	15.5 km	FCC, IC
XBee 900HP BR	RF	900 MHz	24 dBm	-110 dBm	15.5 km	ANATEL
XBee 900HP AU	RF	900 MHz	24 dBm	-110 dBm	15.5 km	RCM
WiFi	WiFi (HTTP(S), FTP, TCP, UDP)	2.4 GHz	17 dBm	-94 dBm	500 m	CE, FCC, IC, ANATEL, RCM
4G EU/BR	4G/3G/2G (HTTP, FTP, TCP, UDP) GPS	800, 850, 900, 1800, 2100, 2600 MHz	4G: class 3 (0.2 W, 23 dBm)	4G: -102 dBm	- km - Typical base station range	CE, ANATEL
4G US	4G/3G/2G (HTTP, FTP, TCP, UDP) GPS	700, 850, 1700, 1900 MHz	4G: class 3 (0.2 W, 23 dBm)	4G: -103 dBm	- km - Typical base station range	FCC, IC, PTCRB, AT&T
4G AU	4G (HTTP, FTP, TCP, UDP)	700, 1800, 2600 MHz	4G: class 3 (0.2 W, 23 dBm)	4G: -102 dBm	- km - Typical base station range	RCM
Sigfox EU	Sigfox	868 MHz	16 dBm	-126 dBm	- km - Typical base station range	CE
Sigfox US	Sigfox	900 MHz	24 dBm	-127 dBm	- km - Typical base station range	FCC, IC
LoRaWAN EU	LoRaWAN	868 MHz	14 dBm	-136 dBm	> 15 km	CE
LoRaWAN US	LoRaWAN	900 MHz	18.5 dBm	-136 dBm	> 15 km	FCC, IC
LoRaWAN AU	LoRaWAN	915-928 MHz	18.5 dBm	-136 dBm	> 15 km	-
LoRaWAN IN	LoRaWAN	865-867 MHz	18.5 dBm	-136 dBm	> 15 km	-

* Line of sight and Fresnel zone clearance with 5dBi dipole antenna.

3.12. Industrial Protocols

Besides the main radio of Waspote Plug & Sense!, it is possible to have an Industrial Protocol module as a secondary communication option. This is offered as an accessory feature.

The available Industrial Protocols are RS-232, RS-485, Modbus (software layer over RS-232 or RS-485) and CAN Bus. This optional feature is accessible through an additional, dedicated socket on the antenna side of the enclosure.



Figure: Industrial Protocols available on Plug & Sense!

Finally, the user can choose between 2 probes to connect the desired Industrial Protocol: A standard DB9 connector and a waterproof terminal block junction box. These options make the connections on industrial environments or outdoor applications easier.



Figure: DB9 probe



Figure: Terminal box probe

3.13. GPS

Any Plug & Sense! node can incorporate a GPS receiver in order to implement real-time asset tracking applications. The user can also take advantage of this accessory to geolocate data on a map. An external, waterproof antenna is provided; its long cable enables better installation for maximum satellite visibility.



Figure: Plug & Sense! node with GPS receiver

Chipset: JN3 (Telit)

Sensitivity:

- Acquisition: -147 dBm
- Navigation: -160 dBm
- Tracking: -163 dBm

Hot start time: <1 s

Cold start time: <35 s

Positional accuracy error < 2.5 m

Speed accuracy < 0.01 m/s

EGNOS, WAAS, GAGAN and MSAS capability

Antenna:

- Cable length: 2 m
- Connector: SMA
- Gain: 26 dBi (active)

Available information: latitude, longitude, altitude, speed, direction, date&time and ephemeris management

3.14. Models

There are some defined configurations of Waspote Plug & Sense! depending on which sensors are going to be used. Waspote Plug & Sense! configurations allow to connect up to six sensor probes at the same time.

Each model takes a different conditioning circuit to enable the sensor integration. For this reason each model allows to connect just its specific sensors.

This section describes each model configuration in detail, showing the sensors which can be used in each case and how to connect them to Waspote. In many cases, the sensor sockets accept the connection of more than one sensor probe. See the compatibility table for each model configuration to choose the best probe combination for the application.

It is very important to remark that each socket is designed only for one specific sensor, so **they are not interchangeable**. Always be sure you connected probes in the right socket, otherwise they can be damaged.

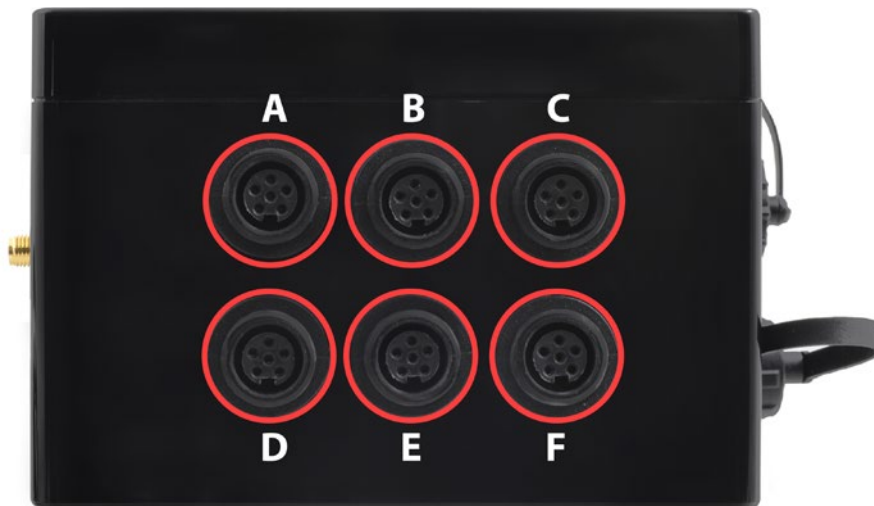

Figure: Identification of sensor sockets

3.15. Smart Agriculture Xtreme

The Plug & Sense! Smart Agriculture Xtreme is an evolution of our Agriculture line with a new selection of high-end professional sensors. It allows to monitor multiple environmental parameters involving a wide range of applications, from plant growing analysis to weather observation. There are sensors for atmospheric and soil monitoring and plants health. Up to 19 sensors can be connected.



Figure: Smart Agriculture Xtreme Waspote Plug & Sense! model

Sensor sockets are configured as shown in the figure below.

Sensor Socket	Sensor probes allowed for each sensor socket	
	Parameter	Reference
A and D	Non-contact surface temperature measurement	9468-P
	Leaf and flower bud temperature	9467-P
	Soil oxygen level	9469-P
	Conductivity, water content and soil temperature 5TE	9402-P
	Conductivity, water content and soil temperature GS3	9464-P
	Soil temperature and volumetric water content	9460-P
	Soil water potentials	9465-P
	Vapor pressure, humidity, temperature, and atmospheric pressure in soil and air	9471-P
	Temperature, air humidity and pressure	9370-P
	Luxes	9325-P
	Ultrasound	9246-P
B	Non-contact surface temperature measurement	9468-P
	Leaf and flower bud temperature	9467-P
	Soil oxygen level	9469-P
	Conductivity, water content and soil temperature 5TE	9402-P
	Conductivity, water content and soil temperature GS3	9464-P
	Soil temperature and volumetric water content	9460-P
	Soil water potentials	9465-P
	Vapor pressure, humidity, temperature, and atmospheric pressure in soil and air	9471-P
	Leaf wetness Phytos 31	9466-P
	Shortwave radiation	9470-P
	Solar Radiation (PAR) for Smart Agriculture Xtreme	9251-PX
	Ultraviolet radiation	9257-PX
	4-20 mA type (generic)	-
C	Non-contact surface temperature measurement	9468-P
	Leaf and flower bud temperature	9467-P
	Soil oxygen level	9469-P
	Conductivity, water content and soil temperature 5TE	9402-P
	Conductivity, water content and soil temperature GS3	9464-P
	Soil temperature and volumetric water content	9460-P
	Soil water potentials	9465-P
	Vapor pressure, humidity, temperature, and atmospheric pressure in soil and air	9471-P
	Dendrometers	9252-PX, 9253-PX, 9254-PX
	Shortwave radiation	9470-P
	Solar Radiation (PAR) for Smart Agriculture Xtreme	9251-PX
	Ultraviolet radiation	9257-PX
E	Shortwave radiation	9470-P
	Solar Radiation (PAR) for Smart Agriculture Xtreme	9251-PX
	Ultraviolet radiation	9257-PX
	Wind and precipitations	9463-P

F	Shortwave radiation	9470-P
	Solar Radiation (PAR) for Smart Agriculture Xtreme	9251-PX
	Ultraviolet radiation	9257-PX
	RS-232 type (generic)	-
	4-20 mA type (generic)	-

Figure: Sensor sockets configuration for Smart Agriculture model

Note: For more technical information about each sensor probe go to the [Development section](#) on the Libelium website.

4. Sensors probes

4.1. General comments

The following sections describe the main features and the general usage for all the sensors probes included in the Plug & Sense! Smart Agriculture Xtreme model.

It is important to remark that Smart Agriculture Xtreme is only available in the Waspote Plug & Sense! line. It is not available for the Waspote OEM line. Besides, keep in mind that Smart Agriculture Xtreme is not compatible with the former Smart Agriculture or Smart Agriculture PRO models. In other words, the sensor probes described in this Guide are **only** compatible with Smart Agriculture Xtreme, because its advanced electronics allow these specific sensor integrations (some exceptions are the BME, Ultrasound or Luminosity sensors).

In order to keep this guide as short as possible, some manufacturer information has been omitted. Libelium encourages the reader to visit the manufacturer websites and to spend some time studying all the technical papers and application notes provided for each sensor. Measured parameters on the great majority of Smart Agriculture applications require a deep knowledge of the environmental parameters and, what is a more, sophisticated measure techniques to obtain the best accuracy.

Additionally, Libelium highly recommends to carry out comprehensive laboratory tests before installing the system on the field, as well as proof of concepts on the field during a reasonable period, before going to a real deploy. Thanks to these good practices, the user will have an idea of the platform behavior, which will be very close to the reality. Parameters like accuracy over time or battery drain can be only measured with real tests.

Finally, always take into account a maintenance factor for each sensor probe. The environmental conditions could affect the sensor behaviour and accuracy therefore it will become mandatory a periodic maintenance for each sensor probe, to watch out things like dirty on sensor probes, measure position or wire connections. The period between these maintenance actions will be different on each application. Contact our Sales department through the next link if you require more information: <http://www.libelium.com/contact>.

4.2. Non-contact surface temperature measurement sensor probe (Apogee SI-411)

The Non-contact surface temperature measurement sensor probe is able to measure the electromagnetic radiation that every object with a temperature above absolute zero emits, which is used to calculate surface temperature from a distance. Thanks to this, the temperature of the object surface is not altered in any way when measuring it.



Figure: The non-contact surface temperature measurement sensor probe (Apogee SI-411)

4.2.1. Specifications

- **Operating environment:** -45 to 80 °C
- **Operation humidity:** 0 ~ 100% RH (non-condensing)
- **Calibration uncertainty (-20 to 65 °C),** when target and detector temperature are within 20 °C: 0.2 °C
- **Calibration uncertainty (-40 to 80 °C),** when target and detector temperature are different by more than 20 °C: 0.5 °C
- **Measurement repeatability:** less than 0.05 °C
- **Stability** (Long-term drift): less than 2 % change in slope per year when germanium filter is maintained in a clean condition
- **Field of view:** 22° half angle
- **Spectral range:** 8 to 14 μm; atmospheric window
- **Dimensions:** 23 mm diameter; 60 mm length
- **Mass:** 190 g (with 5m of lead wire)
- **Cable:** 5 m

4.2.2. Measurement process

The SI-411 sensor provides a digital signal using the SDI-12 protocol.

Reading code:

```
{  
  // 1. Declare an object for the sensor  
  Apogee_SI411 mySensor(AGR_XTR_SOCKET_A);  
  
  // 2. Turn ON the sensor  
  mySensor.ON();  
  
  // 3. Read the sensor. Values stored in class variables  
  // Check complete code example for details  
  mySensor.read();  
  
  // 4. Turn off the sensor  
  mySensor.OFF();  
}
```

You can find a complete example code for reading this sensor probe in the following link: <http://www.libelium.com/development/waspote/examples/ag-xtr-01-SI-411-sensor-reading>

4.2.3. Socket

Connect the infrared radiometer sensor to the Plug & Sense! Smart Agriculture Xtreme in any of the sockets shown in the image below.

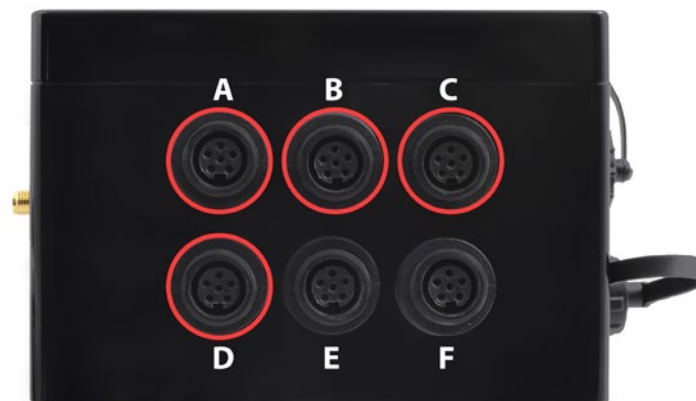

Figure: Available sockets for the SI-411 sensor probe

4.2.4. Installation

When choosing the distance of the sensor to the object to be measured at the installation of the sensor, it must be taken into account that it has a field of view (FOV) of 22° (half angle), as you can see in the image below.

It is necessary to remove the green protective cover to measure, it is only used to protect the sensor when it is not being used.



Figure: Sensor field of view

An Angle mounting bracket (Apogee AM-220) can also be used for the installation. This accessory is recommended to mount the sensor on a pole with an outer diameter from 3.3 to 5.3 cm in different angles.



Figure: Angle mounting bracket (Apogee AM-220)

Looking into above picture, the black plastic part on the right must be facing the pole, while the metal angled part on the left must fix the sensor.

First, attach the accessory to the pole screwing the 2 nuts just enough to hold the accessory to the pole. Keep the 2 washers to avoid the installation loosening.

Then, place the sensor into the accessory, taking into account that the sensor must point towards the desired target.

Finally, adjust the angles by rotating the sensor and hold it into the desired position while the nuts are tightened.



Figure: Angle mounting bracket installation with the SI-411 sensor

You can find the complete sensor manual on the manufacturer's website.

4.2.5. Application examples

- Plant canopy temperature measurement for plant water status estimation
- Road surface temperature measurement for determination of icing conditions
- Terrestrial surface (soil, vegetation, water, snow) temperature measurement in energy balance studies

4.2.6. Certificate of calibration

Together with this sensor we provide a calibration certificate in which the manufacturer ensures that the sensor has passed a calibration procedure with traceability to an accredited laboratory.

4.3. Leaf and flower bud temperature sensor probe (Apogee SF-421)

Frost events may happen in plants even though the ambient temperature is not 0 °C or lower because the canopy temperature can be different than air temperature, this is called radiation frost. The Leaf and bud temperature sensor probe is designed to predict frost events.

Radiation frost occurs when there is a lack of air mixing by the wind near the surface and a negative net long wave radiation balance at the surface.



Figure: Leaf and bud temperature sensor probe (Apogee SF-421)

4.3.1. Specifications

- **Operating temperature:** -50 to 70 °C
- **Operation humidity:** 0 ~ 100% RH
- **Measurement range:** -50 to 70 °C
- **Measurement Uncertainty:**
 - 0.1 °C (from 0 to 70 °C)
 - 0.2 °C (from -25 to 0 °C)
 - 0.4 °C (from -50 to -25 °C)
- **Measurement repeatability:** less than 0.05 °C
- **Stability** (Long-term drift): Less than 0.02 °C per year
- **Equilibration time:** 10 s
- **Self-heating:** Less than 0.01 °C
- **Dimensions:** 57 cm length, 2.1 cm pipe diameter, 7.0 cm disk diameter (see image below)
- **Mass:** 400 g
- **Cable:** 5 m

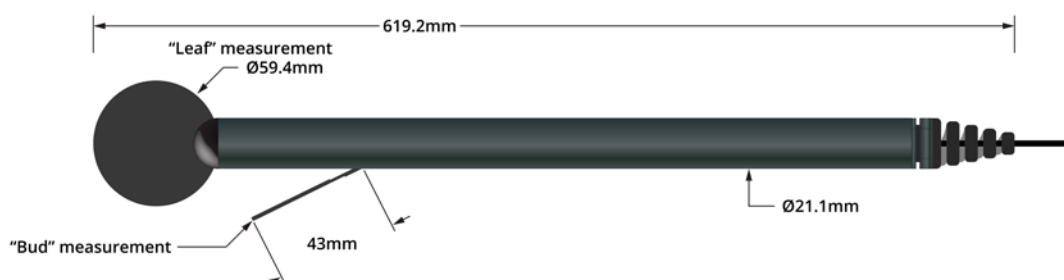

Figure: Radiation frost detector dimensions

4.3.2. Measurement process

The SF-421 sensor provides a digital signal using the SDI-12 protocol.

Reading code:

```
{  
  // 1. Declare an object for the sensor  
  Apogee_SI421 mySensor(AGR_XTR_SOCKET_A);  
  
  // 2. Turn ON the sensor  
  mySensor.ON();  
  
  // 3. Read the sensor. Values stored in class variables  
  // Check complete code example for details  
  mySensor.read();  
  
  // 4. Turn off the sensor  
  mySensor.OFF();  
}
```

You can find a complete example code for reading this sensor probe in the following link: <http://www.libelium.com/development/waspote/examples/ag-xtr-02-SF-421-sensor-reading>

4.3.3. Socket

Connect the SF-421 sensor probe to Plug & Sense! Smart Agriculture Xtreme in any of the sockets shown in the image below.

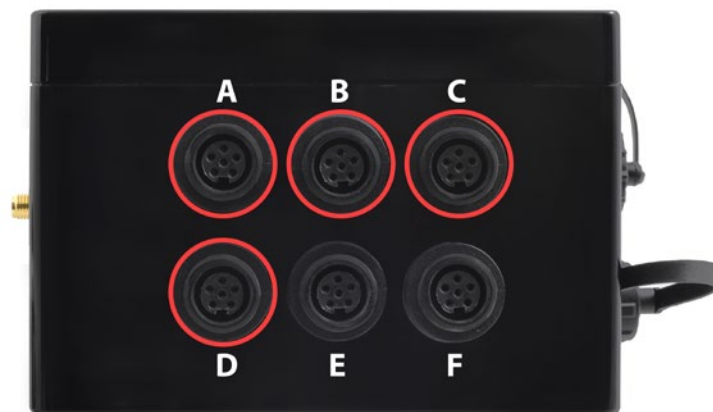

Figure: Available sockets for the SF-421 sensor probe

4.3.4. Installation

The shape of the SF-421 sensor is designed to resemble a plant leaf and flower bud and be able to measure radiation frost events. The sensor should be installed near the plant canopy where the radiation frost detection is required.

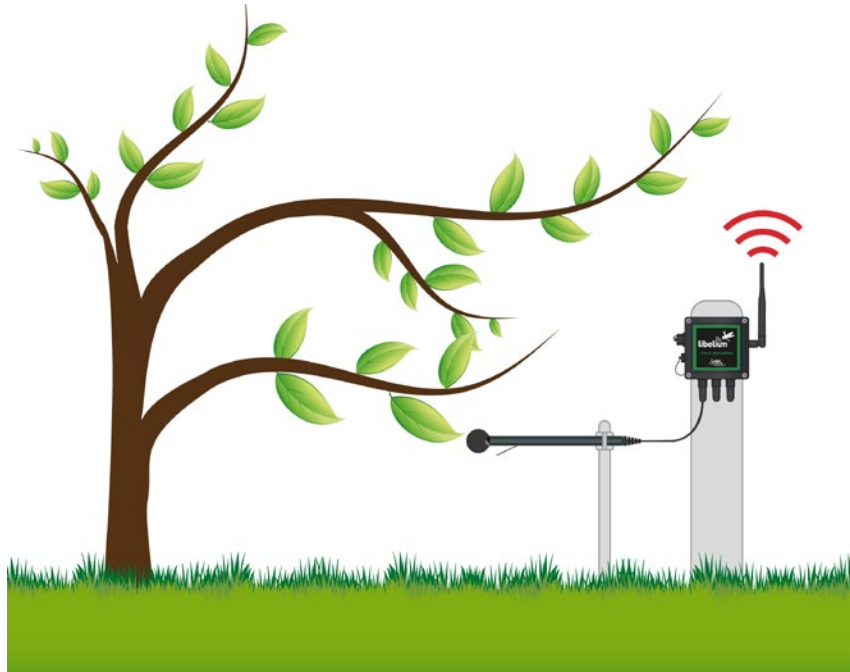

Figure: SF-421 sensor installation

An Angle mounting bracket (Apogee AM-220) can also be used for the installation. This accessory is recommended to mount the sensor on a pole with an outer diameter from 3.3 to 5.3 cm in different angles.



Figure: Angle mounting bracket (Apogee AM-220)

Looking into above picture, the black plastic part on the right must be facing the pole, while the metal angled part on the left must fix the sensor.

First, attach the accessory to the pole screwing the 2 nuts just enough to hold the accessory to the pole. Keep the 2 washers to avoid the installation loosening.

Then, place the sensor into the accessory, taking into account that the sensor must point towards the desired target.

Finally, adjust the angles by rotating the sensor and hold it into the desired position while the nuts are tightened.



Figure: Angle mounting bracket installation with the SF-421 sensor

You can find the complete sensor manual on the manufacturer's website.

4.3.5. Application examples

- Leaf and bud temperature estimates in cropped fields, orchards, and vineyards.
- Detection of potential frost damage to crops.

4.3.6. Quality Assurance Certificate

Together with this sensor we provide a quality assurance certificate in which the manufacturer ensures that the sensor has passed the internal quality procedures.

4.4. Soil oxygen level sensor probe (Apogee SO-411)

Oxygen is the second major constituent of Earth's atmosphere and it is crucial for the development of life. There are sensors which measures oxygen in 2 states: dissolved in a solution and in a gaseous state. The Soil oxygen level sensor probe measures gaseous oxygen.

The Soil oxygen level sensor probe consists of a galvanic cell type sensor and offers a measure of the percentage of the total number of molecules of oxygen in the air. This sensor is specially designed for use in soil or porous media.



Figure: Soil oxygen level sensor probe (Apogee SO-411)



Figure: SO-411 sensor with diffusion head AO-001

4.4.1. Specifications

- **Operating environment:** -20 to 60 °C; 60 to 114 kPa
- **Operation humidity:** 0 ~ 100% RH (non-condensing)
- **Measurement range:** 0 to 100 % O₂
- **Measurement repeatability:** Less than 0.1 % of mV output at 20.95 % O₂
- **Non-linearity:** Less than 1 %
- **Long-term drift** (Non-stability): 1.0 mV per year
- **Oxygen consumption rate:** 2.2 μmol O₂ per day at 20.95 % O₂ and 23 °C
- **Response time:** 60 s
- **Dimensions:** 32 mm diameter, 68 mm length
- **Mass:** 175 g
- **Cable:** 5 m

4.4.2. Measurement process

The SO-411 sensor provides a digital signal using the SDI-12 protocol.

Reading code:

```
{
  // 1. Declare an object for the sensor
  Apogee_S0411 mySensor(AGR_XTR_SOCKET_A);

  // 2. Turn ON the sensor
  mySensor.ON();

  // 3. Initialization delay, necessary for this sensor
  delay(60000);

  // 4. Read the sensor. Values stored in class variables
  // Check complete code example for details
  mySensor.read();

  // 5. Turn off the sensor
  mySensor.OFF();
}
```

You can find a complete example code for reading this sensor probe in the following link: <http://www.libelium.com/development/waspote/examples/ag-xtr-03-SO-411-sensor-reading>

4.4.3. Socket

Connect the SO-411 sensor probe to Plug & Sense! Smart Agriculture Xtreme in any of the sockets shown in the image below.

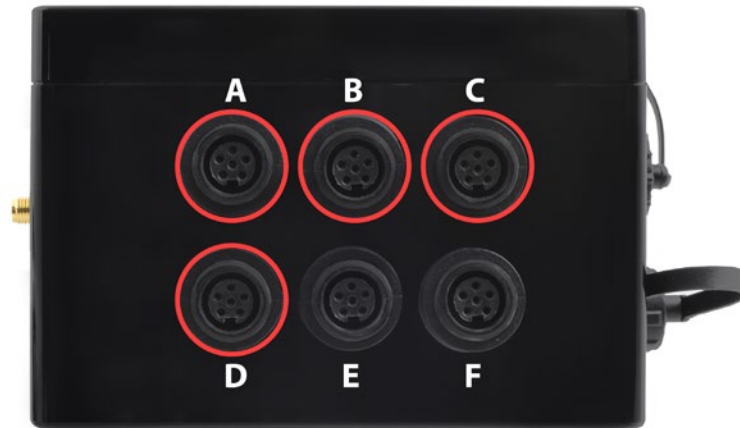

Figure: Available sockets for the SO-411 sensor probe

4.4.4. Installation

The SO-411 sensor is designed to be installed in soil or porous media in vertical position, with the opening pointing down and the cable pointing up.

This sensor can be used with the accessory model A0-001, designed to facilitate measurements in soil or porous media. It consists of a diffusion head that maintains an air pocket and provides protection to the teflon membrane where gas diffusion occurs.



Figure: Diffusion head accessory A0-001

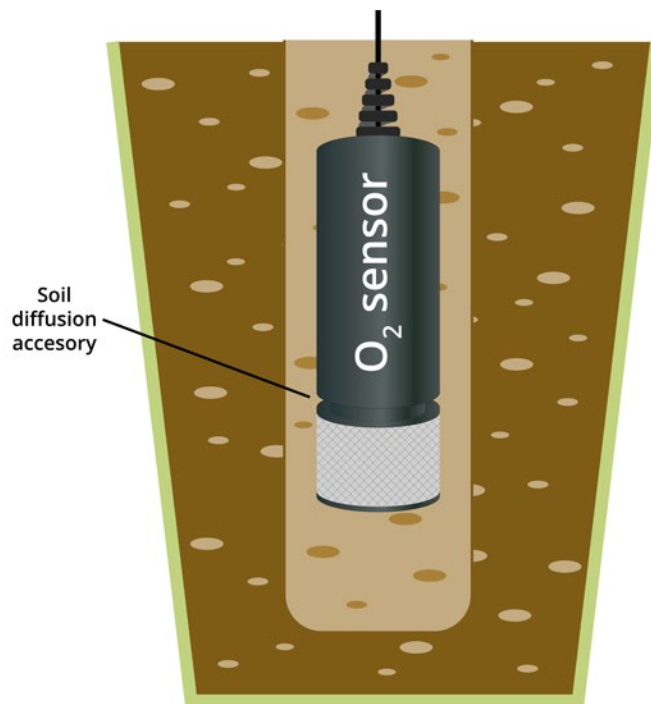

Figure: SO-411 sensor installation with diffusion head accessory

You can find the complete sensor manual on the manufacturer’s website.

4.4.5. Application examples

- Measurement of O₂ in laboratory experiments.
- Monitoring gaseous O₂ in indoor environments for climate control.
- Monitoring of O₂ levels in compost piles and mine tailings.
- Monitoring redox potential in soils.
- Determination of respiration rates through measurement of O₂ consumption in sealed chambers.
- Measurement of O₂ gradients in soil/porous media.

4.4.6. Quality Assurance Certificate

Together with this sensor we provide a quality assurance certificate in which the manufacturer ensures that the sensor has passed the internal quality procedures.

4.5. Shortwave radiation sensor probe (Apogee SP-510)

The Shortwave radiation sensor probe (Apogee SP-510) measures incoming global shortwave radiation from the Sun. Shortwave radiation is radiant energy with wavelengths in the visible (VIS), near-ultraviolet (UV), and near-infrared (NIR) spectra.

This sensor consists of a thermopile detector, acrylic diffuser, heater, and signal processing circuitry mounted in an anodized aluminum housing.



Figure: Shortwave radiation sensor probe (Apogee SP-510)

4.5.1. Specifications

General specifications

- Operating temperature: -50 to 80 °C
- Operation humidity: 0 ~ 100% RH
- Sensitivity (variable from sensor to sensor, typical values listed): 0.057 mV per $W\ m^{-2}$
- Calibration factor (reciprocal of sensitivity): 17.5 $W\ m^{-2}$ per mV
- Calibration uncertainty: $\pm 5\%$
- Calibrated output range: 0 to 114 mV
- Measurement range: 0 to 2000 $W\ m^{-2}$ (net shortwave radiation)
- Measurement repeatability: less than 1%
- Long-term drift (non-stability): less than 2% per year
- Non-linearity: less than 1%
- Detector response time: 0.5 s
- Field of view: 180°
- Spectral range (wavelengths where response is 50% of maximum): 385 to 2105 nm
- Directional (cosine) response: less than 30 $W\ m^{-2}$ up to solar zenith angles of 80°
- Temperature response: less than 5% from -15 to 45 °C
- Cable length: 5 m

4.5.2. Measurement process

The SP-510 sensor provides an analog signal.

Reading code:

```
{  
  // 1. Declare an object for the sensor  
  Apogee_SP510 mySensor(AGR_XTR_SOCKET_B);  
  
  // 2. Turn ON the sensor  
  mySensor.ON();  
  
  // 3. Read the sensor. Values stored in class variables  
  // Check complete code example for details  
  mySensor.read();  
  
  // 4. Turn off the sensor  
  mySensor.OFF();  
}
```

You can find a complete example code for reading this sensor probe in the following link: <http://www.libelium.com/development/waspote/examples/ag-xtr-06-SP-510-sensor-reading>

4.5.3. Socket

Connect the SP-510 sensor probe to Plug & Sense! Smart Agriculture Xtreme in any of the sockets shown in the image below.

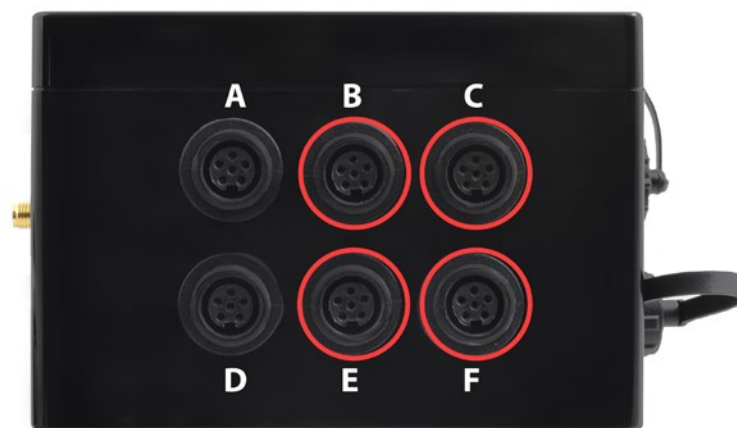

Figure: Available sockets for the SP-510 sensor probe

4.5.4. Installation

The SP-510 sensor includes a nylon mounting screw on the base in order to mount the sensor on a solid surface.

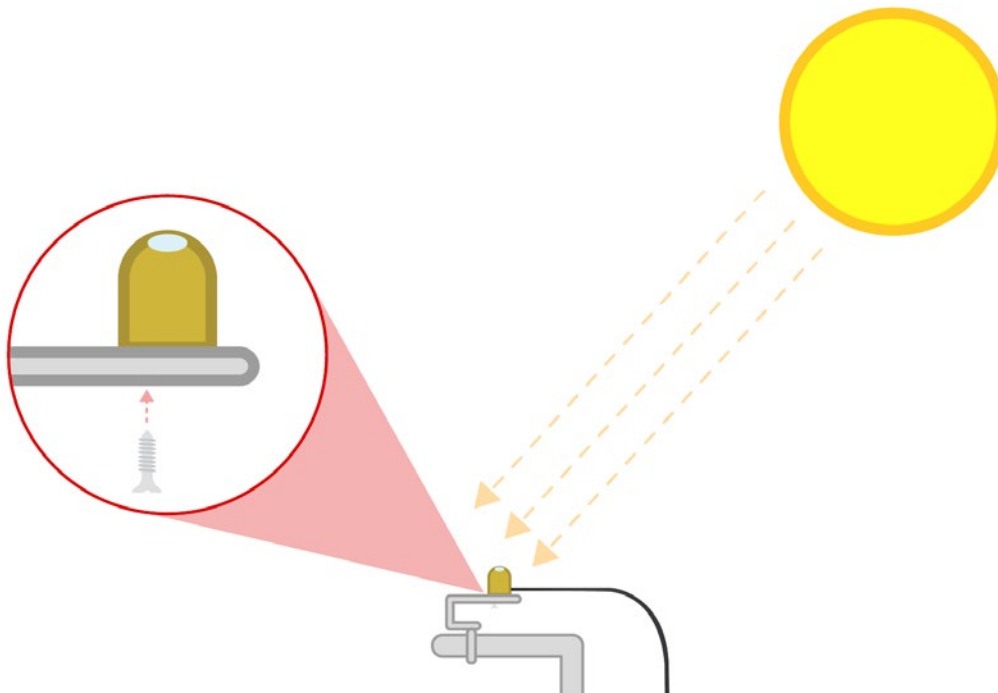

Figure: Pyranometer installation

The Solar sensors mounting accessory can also be used for the installation. This accessory is optional but highly recommended for the solar sensors. With this accessory you will get a secure fastening while keeping the sensor as level as possible, always pointing up.

The accessory is composed of 2 main parts:

- A - Mounting bracket: it will be fastened to a pipe or mast with its u-bolt
- B - Leveling plate: it holds the sensor and includes a bubble level



Figure: Solar sensors mounting accessory

Mounting the system is very easy, just follow these steps:

- 1 - Attach the solar sensor to the leveling plate, in its central hole. Use the black nylon screw (every sensor comes with one, find it on its bottom) and a screwdriver.
- 2 - Fasten the leveling plate to the mounting bracket with the 3 long gray screws. Do not insert them too firmly, the final adjustment is done later.
- 3 - Decide if you want to mount the whole structure to a vertical or horizontal pipe or mast (its outer diameter can go from 3.3 to 5.3 cm). Depending on horizontal or vertical configuration, you will use the bottom or the side of the mounting bracket.
- 4 - Place the black plastic piece in contact with the pipe. Then use the u-bolt to grab the mounting bracket to the pipe. On both ends of the u-bolt, insert first the washers, then the lock washers and finally the nuts.
- 5 - Place the structure in the desired position and tighten the nuts firmly with a wrench.

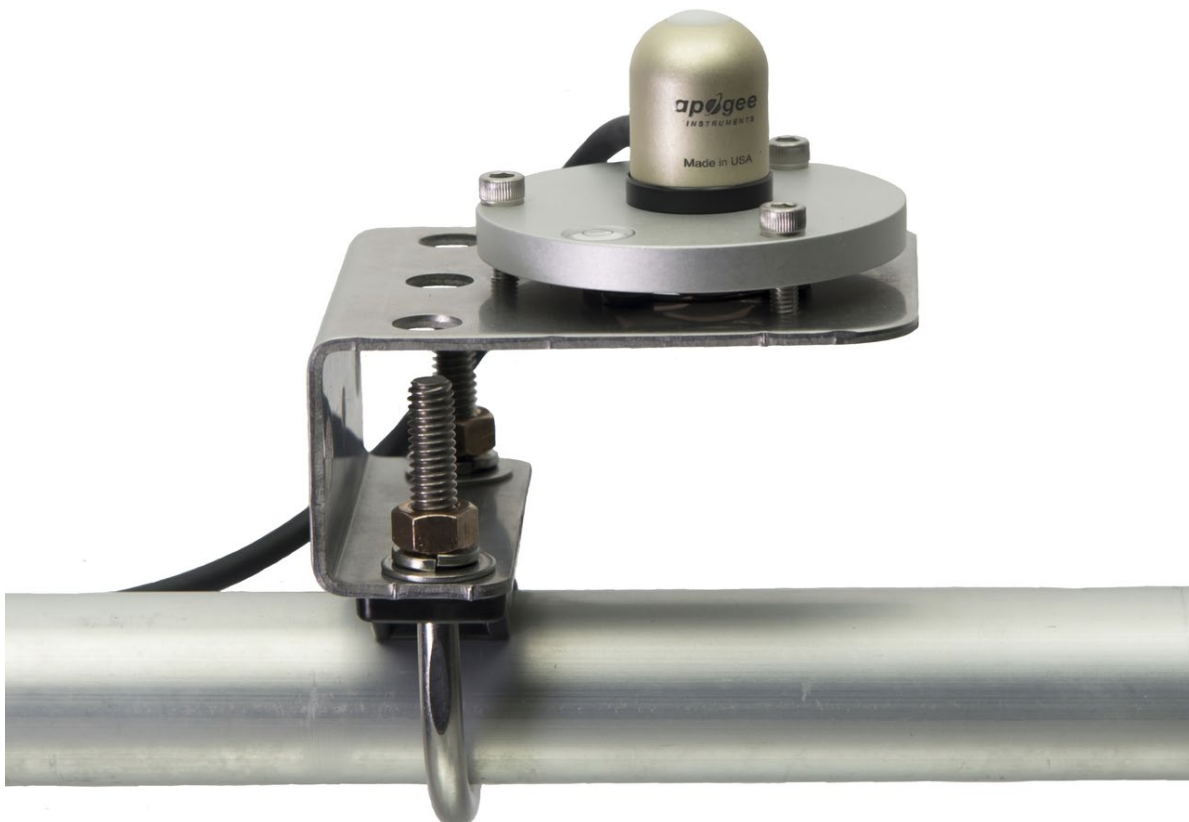

Figure: Final look of the whole structure

6 - You may take advantage of the holes on the mounting bracket and the pipe to secure the cable of the sensor, avoiding its rotation. You can do that with some cable ties. To minimize azimuth error, the sensor should be mounted with the cable pointing toward true north in the northern hemisphere or true south in the southern hemisphere. Azimuth error is typically less than 1%, but it is easy to minimize by proper cable orientation.

7 - Once installed, use the long gray screws of the plate for fine adjustment of the level, making sure the bubble is inside the black circle. The wave spring will keep the leveling plate in place.

Note: the sensor should be mounted so that obstructions (pipe/mast, sensors, enclosures, leaves, walls, etc) do not shade the sensor.

You can find the complete sensor manual on the manufacturer's website.

4.5.5. Application examples

- Incoming shortwave radiation measurement in agricultural, ecological, and hydrological weather networks
- Optimization of photo-voltaic systems

4.5.6. Certificate of calibration

Together with this sensor we provide a calibration certificate in which the manufacturer ensures that the sensor has passed a calibration procedure with traceability to an accredited laboratory.

4.6. Solar radiation sensor probe for Smart Agriculture Xtreme (Apogee SQ-110)

Photosynthetically active radiation (PAR) is the radiation that drives photosynthesis and is typically defined as total radiation across a range from 400 to 700 nm. PAR is often expressed as photosynthetic photon flux density (PPFD): photon flux in units of micromoles per square meter per second ($\mu\text{mol}\cdot\text{m}^{-2}\cdot\text{s}^{-1}$).



Figure: Solar radiation sensor probe for Smart Agriculture Xtreme (Apogee SQ-110)

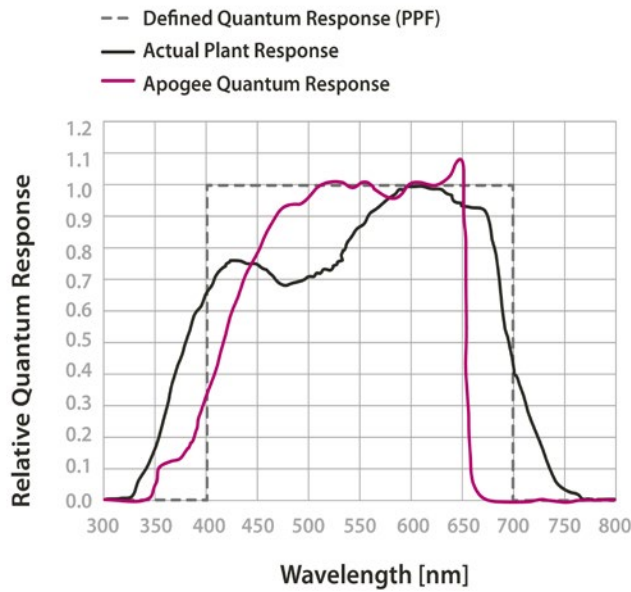

Figure: Graph of the spectral response of the PAR sensor (Apogee SQ-110) compared to the photosynthetic response of a plant

4.6.1. Specifications

- **Operation temperature:** -40 ~ 70 °C
- **Operation humidity:** 0 ~ 100% RH
- **Sensitivity:** 0.2 mV / $\mu\text{mol}\cdot\text{m}^{-2}\cdot\text{s}^{-1}$
- **Calibration factor** (Reciprocal of sensitivity): 5 $\mu\text{mol}\cdot\text{m}^{-2}\cdot\text{s}^{-1}$ / mV
- **Non-linearity:** < 1% (up to 4000 $\mu\text{mol}\cdot\text{m}^{-2}\cdot\text{s}^{-1}$ / mV)
- **Non-stability** (long-term drift): <2% per year
- **Spectral range:** 410 ~ 655 nm
- **Repeatability:** <0.5%
- **Diameter:** 2.4 cm
- **Height:** 2.8 cm
- **Cable length:** 5 m

4.6.2. Measurement process

The SQ-110 sensor provides an analog signal.

Reading code:

```
{  
  // 1. Declare an object for the sensor  
  Apogee_SQ110 mySensor(AGR_XTR_SOCKET_B);  
  
  // 2. Turn ON the sensor  
  mySensor.ON();  
  
  // 3. Read the sensor. Values stored in class variables  
  // Check complete code example for details  
  mySensor.read();  
  
  // 4. Turn off the sensor  
  mySensor.OFF();  
}
```

You can find a complete example code for reading this sensor probe in the following link: <http://www.libelium.com/development/waspote/examples/ag-xtr-05-SQ-110-sensor-reading>

4.6.3. Socket

Connect the SQ-110 sensor probe to Plug & Sense! Smart Agriculture Xtreme in any of the sockets shown in the image below.

Note: This sensor has a specific wiring for the Plug & Sense! Smart Agriculture Xtreme model, so it is not compatible with other Plug & Sense! models and vice versa. Refer to our Sales department for more information.

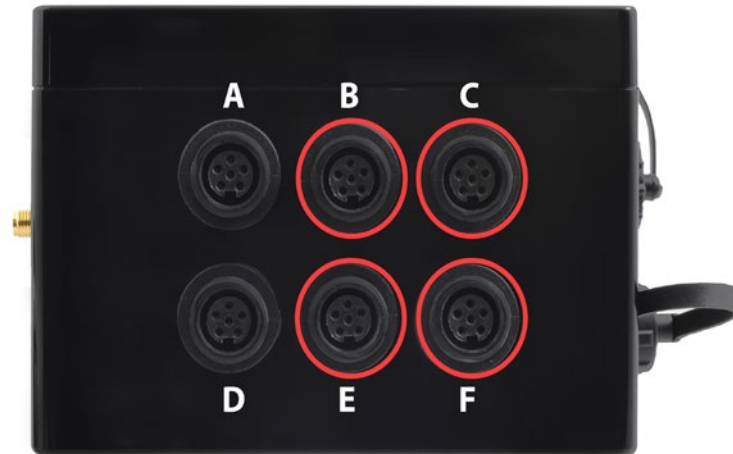

Figure: Available sockets for the SQ-110 sensor probe

4.6.4. Installation

The SQ-110 sensor includes a nylon mounting screw on the base in order to mount the sensor on a solid surface.

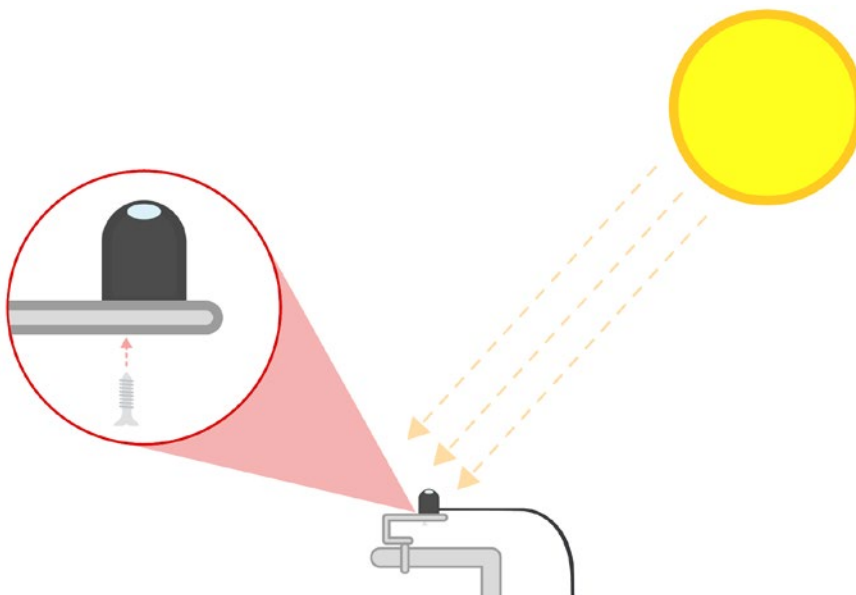

Figure: SQ-110 sensor installation

The Solar sensors mounting accessory can also be used for the installation. This accessory is optional but highly recommended for the solar sensors. With this accessory you will get a secure fastening while keeping the sensor as level as possible, always pointing up.

The accessory is composed of 2 main parts:

A - Mounting bracket: it will be fastened to a pipe or mast with its u-bolt

B - Leveling plate: it holds the sensor and includes a bubble level



Figure: Solar sensors mounting accessory

Mounting the system is very easy, just follow these steps:

- 1 - Attach the solar sensor to the leveling plate, in its central hole. Use the black nylon screw (every sensor comes with one, find it on its bottom) and a screwdriver.
- 2 - Fasten the leveling plate to the mounting bracket with the 3 long gray screws. Do not insert them too firmly, the final adjustment is done later.
- 3 - Decide if you want to mount the whole structure to a vertical or horizontal pipe or mast (its outer diameter can go from 3.3 to 5.3 cm). Depending on horizontal or vertical configuration, you will use the bottom or the side of the mounting bracket.
- 4 - Place the black plastic piece in contact with the pipe. Then use the u-bolt to grab the mounting bracket to the pipe. On both ends of the u-bolt, insert first the washers, then the lock washers and finally the nuts.
- 5 - Place the structure in the desired position and tighten the nuts firmly with a wrench.



Figure: Final look of the whole structure

6 - You may take advantage of the holes on the mounting bracket and the pipe to secure the cable of the sensor, avoiding its rotation. You can do that with some cable ties. To minimize azimuth error, the sensor should be mounted with the cable pointing toward true north in the northern hemisphere or true south in the southern hemisphere. Azimuth error is typically less than 1%, but it is easy to minimize by proper cable orientation.

7 - Once installed, use the long gray screws of the plate for fine adjustment of the level, making sure the bubble is inside the black circle. The wave spring will keep the leveling plate in place.

Note: the sensor should be mounted so that obstructions (pipe/mast, sensors, enclosures, leaves, walls, etc) do not shade the sensor.

You can find the complete sensor manual on the manufacturer's website.

4.6.5. Application examples

Photosynthetic photon flux density (PPFD) measures in:

- Plant canopies in outdoor environments
- Greenhouses and growth chambers
- Evapotranspiration analysis
- Aquatic environments, including salt water aquariums where corals are grown

4.6.6. Certificate of calibration

Together with this sensor we provide a calibration certificate in which the manufacturer ensures that the sensor has passed a calibration procedure with traceability to an accredited laboratory.

4.7. Ultraviolet radiation sensor probe for Smart Agriculture Xtreme (Apogee SU-100)

Ultraviolet (UV) radiation is typically defined as total radiation across a range from 100 to 400 nm and is subdivided into 3 wavelength ranges: UV-A (315 to 400 nm), UV-B (280 to 315 nm) and UV-C (100 to 280 nm). Much of the UV-B and all of the UV-C wavelengths from the sun are absorbed by the Earth’s atmosphere.

The Ultraviolet radiation sensor probe for Smart Agriculture Xtreme (Apogee SU-100) detects UV radiation from 250 to 400 nm and is calibrated in photon flux units of micromoles per square meter per second ($\mu\text{mol}\cdot\text{m}^{-2}\cdot\text{s}^{-1}$). .



Figure: Ultraviolet radiation sensor probe for Smart Agriculture Xtreme (Apogee SU-100)

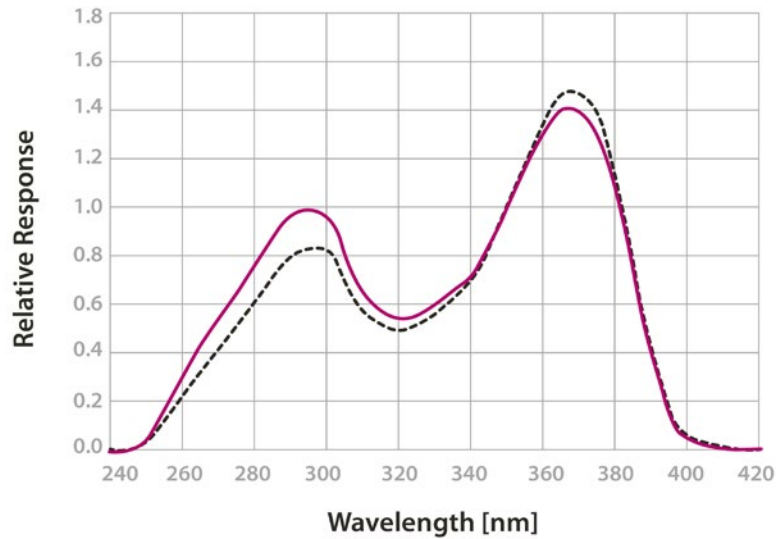

Figure: Graph of the spectral response of the SU-100 sensor probe compared to the photosynthetic response of a plant

4.7.1. Specifications

- **Operation temperature:** -40 to 70 °C
- **Operation humidity:** 0 to 100 %
- **Sensitivity:** 0.2 mV / $\mu\text{mol}\cdot\text{m}^{-2}\text{s}^{-1}$
- **Calibration factor** (reciprocal of sensitivity): 5.0 $\mu\text{mol}\cdot\text{m}\cdot\text{m}^{-2}\text{s}^{-1}$ / mV
- **Non-stability** (long-term drift): <3% per year
- **Non-linearity:** <1% (up to 300 $\mu\text{mol}\cdot\text{m}^{-2}\text{s}^{-1}$)
- **Spectral range:** 250 ~ 400 nm
- **Repeatability:** <1%
- **Diameter:** 2.4 cm
- **Height:** 2.8 cm
- **Cable length:** 5 m

4.7.2. Measurement process

The SU-100 sensor provides an analog signal.

Reading code:

```
{  
  // 1. Declare an object for the sensor  
  Apogee_SU100 mySensor(AGR_XTR_SOCKET_B);  
  
  // 2. Turn ON the sensor  
  mySensor.ON();  
  
  // 3. Read the sensor. Values stored in class variables  
  // Check complete code example for details  
  mySensor.read();  
  
  // 4. Turn off the sensor  
  mySensor.OFF();  
}
```

You can find a complete example code for reading this sensor probe in the following link: <http://www.libelium.com/development/waspote/examples/ag-xtr-04-SU100-sensor-reading>

4.7.3. Socket

Connect the SU-100 sensor probe to Plug & Sense! Smart Agriculture Xtreme in any of the sockets shown in the image below.

Note: This sensor has a specific wiring for the Plug & Sense! Smart Agriculture Xtreme model, so it is not compatible with other Plug & Sense! models and vice versa. Refer to our Sales department for more information.

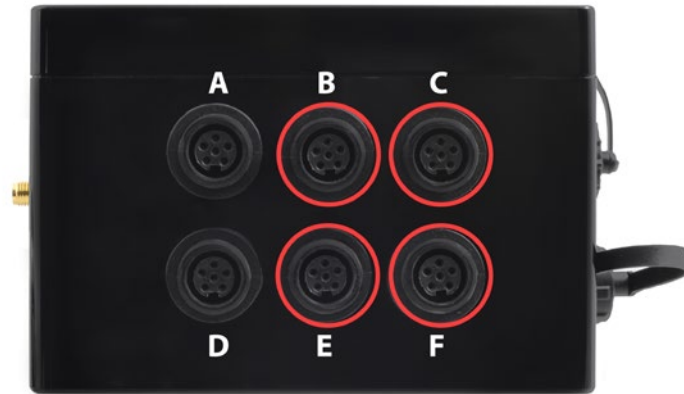

Figure: Available sockets for the SU-100 sensor probe

4.7.4. Installation

The SU-100 sensor includes a nylon mounting screw on the base in order to mount the sensor on a solid surface.

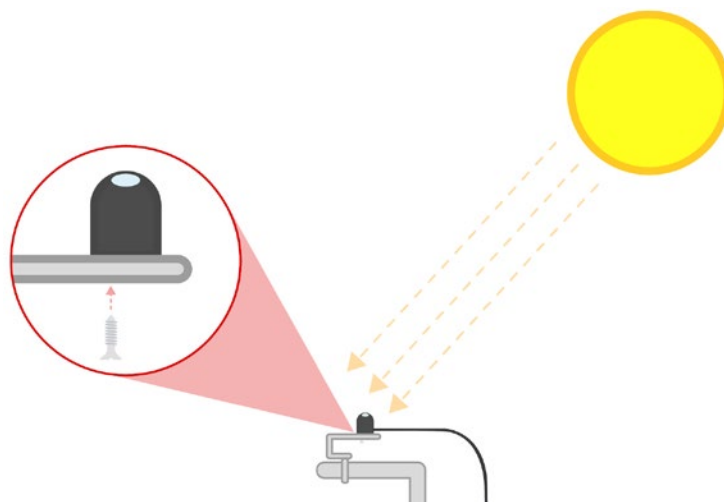

Figure: SU-100 sensor probe installation

The Solar sensors mounting accessory can also be used for the installation. This accessory is optional but highly recommended for the solar sensors. With this accessory you will get a secure fastening while keeping the sensor as level as possible, always pointing up.

The accessory is composed of 2 main parts:

- A - Mounting bracket: it will be fastened to a pipe or mast with its u-bolt.
- B - Leveling plate: it holds the sensor and includes a bubble level.



Figure: Solar sensors mounting accessory

Mounting the system is very easy, just follow these steps:

- 1 - Attach the solar sensor to the leveling plate, in its central hole. Use the black nylon screw (every sensor comes with one, find it on its bottom) and a screwdriver.
- 2 - Fasten the leveling plate to the mounting bracket with the 3 long gray screws. Do not insert them too firmly, the final adjustment is done later.
- 3 - Decide if you want to mount the whole structure to a vertical or horizontal pipe or mast (its outer diameter can go from 3.3 to 5.3 cm). Depending on horizontal or vertical configuration, you will use the bottom or the side of the mounting bracket.
- 4 - Place the black plastic piece in contact with the pipe. Then use the u-bolt to grab the mounting bracket to the pipe. On both ends of the u-bolt, insert first the washers, then the lock washers and finally the nuts.
- 5 - Place the structure in the desired position and tighten the nuts firmly with a wrench.

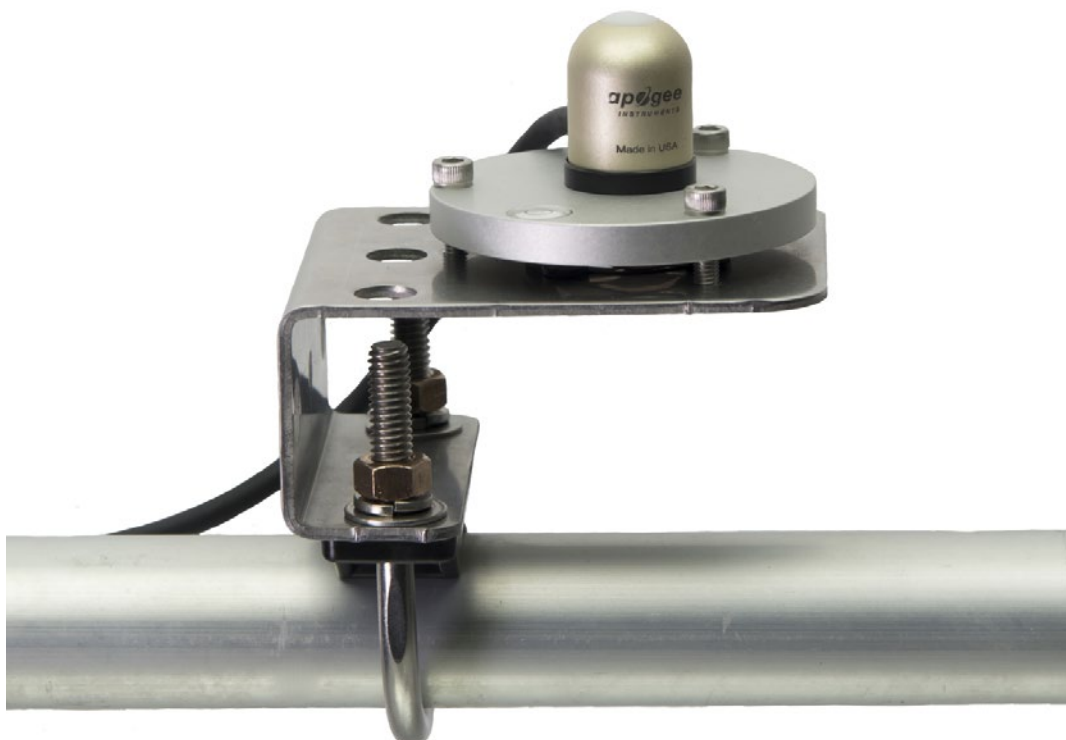

Figure: Final look of the whole structure

6 - You may take advantage of the holes on the mounting bracket and the pipe to secure the cable of the sensor, avoiding its rotation. You can do that with some cable ties. To minimize azimuth error, the sensor should be mounted with the cable pointing toward true north in the northern hemisphere or true south in the southern hemisphere. Azimuth error is typically less than 1%, but it is easy to minimize by proper cable orientation.

7 - Once installed, use the long gray screws of the plate for fine adjustment of the level, making sure the bubble is inside the black circle. The wave spring will keep the leveling plate in place.

Note: the sensor should be mounted so that obstructions (pipe/mast, sensors, enclosures, leaves, walls, etc) do not shade the sensor.

You can find the complete sensor manual on the manufacturer's website.

4.7.5. Application examples

UV radiation measurement in:

- Outdoor environments
- Laboratory use with artificial light sources (e.g. germicidal lamps)
- Monitoring the filter ability and stability of different materials

4.7.6. Certificate of calibration

Together with this sensor we provide a calibration certificate in which the manufacturer ensures that the sensor has passed a calibration procedure with traceability to an accredited laboratory.

4.8. Temperature, humidity and pressure sensor probe (Bosch BME280)

The Bosch BME280 includes a humidity sensor that features an extremely fast response time which supports performance requirements for emerging applications such as context awareness, and high accuracy over a wide temperature range. The pressure sensor is an absolute barometric pressure sensor with features exceptionally high accuracy and resolution at very low noise. The integrated temperature sensor has been optimized for very low noise and high resolution. It is primarily used for temperature compensation of the pressure and humidity sensors, and can also be used for estimating ambient temperature.



Figure: Temperature, humidity and pressure sensor (Bosch BME280)

4.8.1. Specifications

Temperature sensor

- Operational range: -40 ~ +85 °C
- Full accuracy range: 0 ~ +65 °C
- Accuracy: ± 1 °C (range 0 °C ~ +65 °C)
- Response time: 1.65 seconds (63% response from +30 to +125 °C).

Humidity sensor

- Measurement range: 0 ~ 100% of relative humidity (for temperatures < 0 °C and > 60 °C see figure below)
Accuracy: < $\pm 3\%$ RH (at 25 °C, range 20 ~ 80%)
- Hysteresis: $\pm 1\%$ RH
- Operating temperature: -40 ~ +85 °C
- Response time (63% of step 90% to 0% or 0% to 90%): 1 second

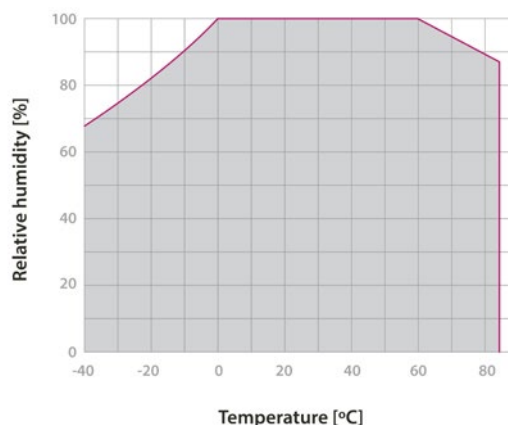

Figure: Humidity sensor operating range

Pressure sensor

- Measurement range: 30 ~ 110 kPa
- Operational temperature range: -40 ~ +85 °C
- Full accuracy temperature range: 0 ~ +65 °C
- Absolute accuracy: ± 0.1 kPa (0 ~ 65 °C)

4.8.2. Measurement process

The Temperature, humidity and pressure sensor provides a digital signal using the I2C protocol.

Reading code:

```
{
  // 1. Declare an object for the sensor
  bme mySensor(AGR_XTR_SOCKET_A);

  // 2. Turn ON the sensor
  mySensor.ON();

  // 3. Read the sensor. Store parameters in local variables
  float temperature = mySensor.getTemperature();
  float humidity = mySensor.getHumidity();
  float pressure = mySensor.getPressure();

  // 4. Turn off the sensor
  mySensor.OFF();
}
```

You can find a complete example code for reading this sensor probe in the following link: <http://www.libelium.com/development/waspote/examples/ag-xtr-16-BME280-sensor-reading>

4.8.3. Socket

Connect the Temperature, humidity and pressure sensor probe (Bosch BME280) to Plug & Sense! Smart Agriculture Xtreme in any of the sockets shown in the image below.

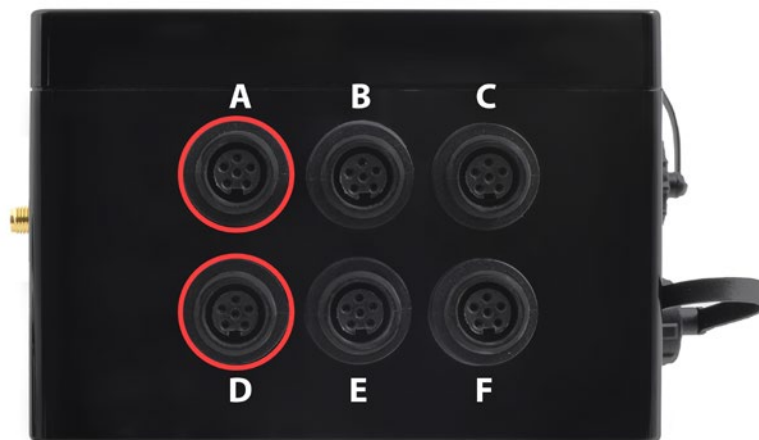

Figure: Available sockets for the Temperature, humidity and pressure sensor probe (Bosch BME280)

4.8.4. Application examples

- Weather observation and forecast
- Evapotranspiration analysis
- Control heating, ventilation or air conditioning in greenhouses
- Warning regarding dryness or high temperatures

4.9. Conductivity, water content and soil temperature GS3 sensor probe (Decagon GS3)

The Conductivity, water content and soil temperature sensor probe (Decagon GS3) can measure many types of growing media, specially in greenhouse applications where the probe can be inserted easily into different types of soilless substrates. The GS3 sensor determines volumetric water content (VWC) by measuring the dielectric constant (ϵ_a) of the medium using capacitance / frequency-domain technology, the temperature using a thermistor, and electrical conductivity using a stainless steel electrode array.



Figure: Conductivity, water content and soil temperature GS3 sensor probe (Decagon GS3)

4.9.1. Specifications

General specifications

- Operating temperature: -40 to 60 °C
- Dielectric measurement frequency: 70 MHz
- Measurement time: 150 ms
- Dimensions: 9.3 x 2.4 x 6.5 cm
- Prong length: 5.5 cm
- Cable length: 5 m

Volumetric water content

- Accuracy: ϵ_a : $\pm 1 \epsilon_a$ (unitless) from 1 to 40 (soil range), $\pm 15\%$ from 40 to 80
- Resolution:
 - $0.1 \epsilon_a$ (unitless) from 1 to 20
 - $< 0.75 \epsilon_a$ (unitless) from 20 to 80
 - $0.002 \text{ m}^3 / \text{m}^3$ (0.2% VWC) from 0 to 40% VWC
 - $0.001 \text{ m}^3 / \text{m}^3$ (0.1% VWC) $> 40\%$ VWC
- Range: Apparent dielectric permittivity (ϵ_a): 1 (air) to 80 (water)

Bulk electrical conductivity

- Accuracy: $\pm 5\%$ from 0 to 5 dS/m, $\pm 10\%$ from 5 to 23 dS/m
- Resolution: 0.001 dS/m from 0 to 23 dS/m
- Range: 0 to 25 dS/m (bulk)

Temperature

- Accuracy: ± 1 °C
- Resolution: 0.1 °C
- Range: -40 to 60 °C

4.9.2. Measurement process

The GS3 sensor provides a digital signal using the SDI-12 protocol.

Reading code:

```
{
  // 1. Declare an object for the sensor
  Decagon_GS3 mySensor(AGR_XTR_SOCKET_A);

  // 2. Turn ON the sensor
  mySensor.ON();

  // 3. Read the sensor. Values stored in class variables
  // Check complete code example for details
  mySensor.read();

  // 4. Turn off the sensor
  mySensor.OFF();
}
```

Volumetric water content (VWC) calculation

The GS3 sensor provides the dielectric permittivity (ϵ_a) of the surrounding medium. The dielectric permittivity value must be converted in the code to a particular substrate by a calibration equation specific to the media you are working in.

The calibration equation for several potting soils, perlite, and peat moss at salinities ranging from 0 to > 4 dS/m is:

$$VWC\left(\frac{m^3}{m^3}\right) = 0.118 \sqrt{\epsilon_a} - 0.117$$

The calibration equation for mineral soils ranging from 0 to > 5 dS/m is:

$$VWC\left(\frac{m^3}{m^3}\right) = 5.89 \cdot 10^{-6} \epsilon_a^3 - 7.62 \cdot 10^{-4} \epsilon_a^2 + 3.67 \cdot 10^{-2} \epsilon_a - 7.53 \cdot 10^{-2}$$

You can find a complete example code for reading this sensor probe and for calculating VWC for mineral soil in the following link: <http://www.libelium.com/development/waspote/examples/ag-xtr-07-GS3-sensor-reading>

4.9.3. Socket

Connect the GS3 sensor probe to Plug & Sense! Smart Agriculture Xtreme in any of the sockets shown in the image below.

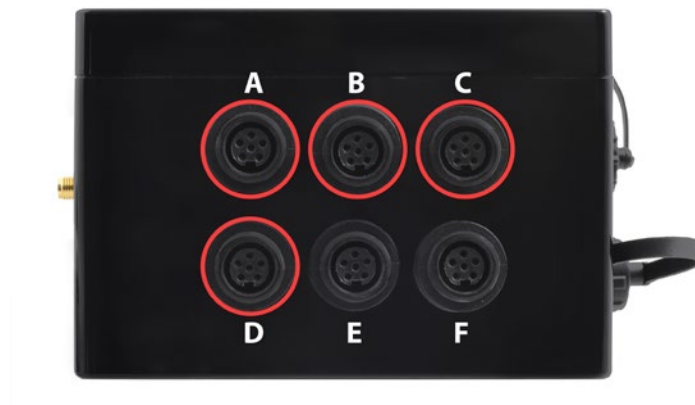

Figure: Available sockets for the GS3 sensor probe

4.9.4. Installation

The GS3 sensor can be inserted into soilless substrates in different ways. However, the orientation of the sensor does affect the sensor readings. Please keep in mind that the sensor only measures the VWC in its sphere of influence.

Sensors can either be inserted into the top of the plant pot or into the side of the root ball. Insertion into the side of the root ball may be the best option, as it will give the best indication of the water available to the plant.

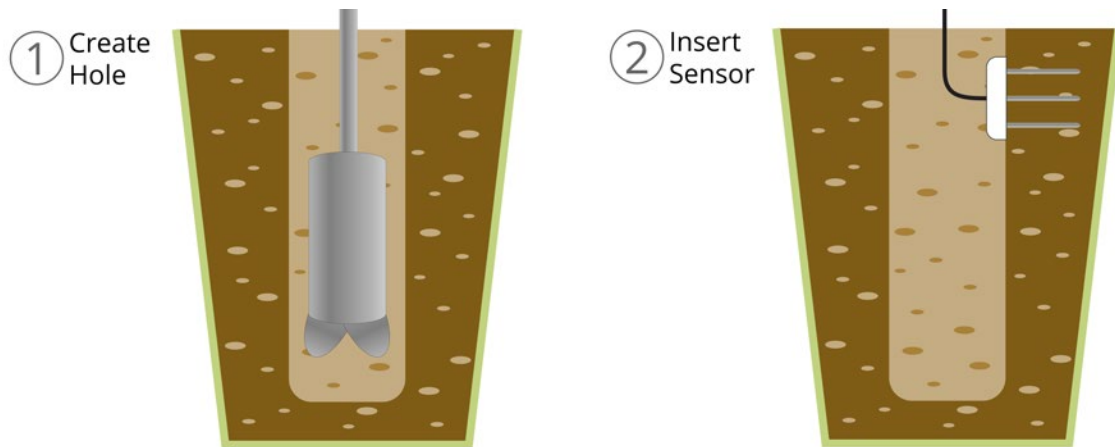

Figure: GS3 sensor installation

You can find the complete sensor manual on the manufacturer's website.

4.9.5. Application examples

- Maintain good soil contact and compensate for air gaps in the substrate of potting soil or soilless medias
- Greenhouse substrate monitoring
- Irrigation management
- Salt management
- Fertilizer movement
- Modeling processes that are affected by temperature

4.9.6. Quality Assurance Certificate

Together with this sensor we provide a quality assurance certificate in which the manufacturer ensures that the sensor has passed the internal quality procedures.

4.10. Conductivity, water content and soil temperature 5TE sensor probe (Decagon 5TE)

The Conductivity, water content and soil temperature sensor probe (Decagon 5TE) can measure volumetric water content, electrical conductivity, and temperature of soil. The sensor uses an oscillator running at 70 MHz to measure the dielectric permittivity of soil to determine the water content (VWC). A thermistor in thermal contact with the sensor prongs provides the soil temperature, while the screws on the surface of the sensor form a two-sensor electrical array to measure electrical conductivity.



Figure: Conductivity, water content and soil temperature 5TE sensor probe (Decagon 5TE)

4.10.1. Specifications

General specifications

- Operating temperature: -40 to 60 °C
- Dielectric measurement frequency: 70 MHz
- Measurement time: 150 ms
- Dimensions: 10 cm x 3.2 cm x 0.7 cm
- Prong length: 5.2 cm
- Cable length: 5 m

Volumetric water content

- Range: Apparent dielectric permittivity (ϵ_a): 1 (air) to 80 (water)
- Resolution:
 - $0.1 \epsilon_a$ (unitless) from 1 to 20,
 - $< 0.75 \epsilon_a$ (unitless) from 20 to 80
 - $0.0008 \text{ m}^3 / \text{m}^3$ (0.08% VWC) from 0 to 50% VWC
- Accuracy: ϵ_a : $\pm 1 \epsilon_a$ (unitless) from 1 to 40 (soil range), $\pm 15\%$ from 40 to 80 (VWC)

Bulk electrical conductivity

- Range: 0 to 23 dS/m (bulk)
- Resolution: 0.01 dS/m from 0 to 7 dS/m, 0.05 dS/m from 7 to 23 dS/m
- Accuracy: $\pm 10\%$ from 0 to 7 dS/m

Temperature

- Range: -40 to 60 °C
- Resolution: 0.1 °C
- Accuracy: ± 1 °C

4.10.2. Measurement process

The water content, electrical conductivity, and temperature sensor (Decagon 5TE) provides a digital signal using SDI-12 protocol.

You can find a complete example code for reading this sensor in the following link:

```
{
  // 1. Declare an object for the sensor
  Decagon_5TE mySensor(AGR_XTR_SOCKET_A);

  // 2. Turn ON the sensor
  mySensor.ON();

  // 3. Read the sensor. Values stored in class variables
  // Check complete code example for details
  mySensor.read();

  // 4. Turn off the sensor
  mySensor.OFF();
}
```

Volumetric water content (VWC) calculation

The 5TE sensor provides the dielectric permittivity (ϵ_a) of the surrounding medium. The dielectric permittivity value must be converted in the code to a particular substrate by a calibration equation specific to the media you are working in.

The calibration equation for mineral soil (Topp equation) is:

$$VWC\left(\frac{m^3}{m^3}\right) = 4.3 \cdot 10^{-6} \epsilon_a^3 - 5.5 \cdot 10^{-4} \epsilon_a^2 + 2.92 \cdot 10^{-2} \epsilon_a - 5.3 \cdot 10^{-2}$$

The calibration equation for potting soil is:

$$VWC\left(\frac{m^3}{m^3}\right) = 2.25 \cdot 10^{-5} \epsilon_a^3 - 2.06 \cdot 10^{-3} \epsilon_a^2 + 7.24 \cdot 10^{-2} \epsilon_a - 0.247$$

The calibration equation for rockwool is:

$$VWC\left(\frac{m^3}{m^3}\right) = -1.68 \cdot 10^{-3} \epsilon_a^2 + 6.56 \cdot 10^{-2} \epsilon_a + 0.0266$$

The calibration equation for perlite is:

$$VWC\left(\frac{m^3}{m^3}\right) = -1.07 \cdot 10^{-3} \epsilon_a^2 + 5.25 \cdot 10^{-2} \epsilon_a - 0.0685$$

You can find a complete example code for reading this sensor probe and for calculating VWC for mineral soil in the following link: <http://www.libelium.com/development/waspote/examples/ag-xtr-08-5TE-sensor-reading>

4.10.3. Socket

Connect the 5TE sensor probe to Plug & Sense! Smart Agriculture Xtreme in any of the sockets shown in the image below.

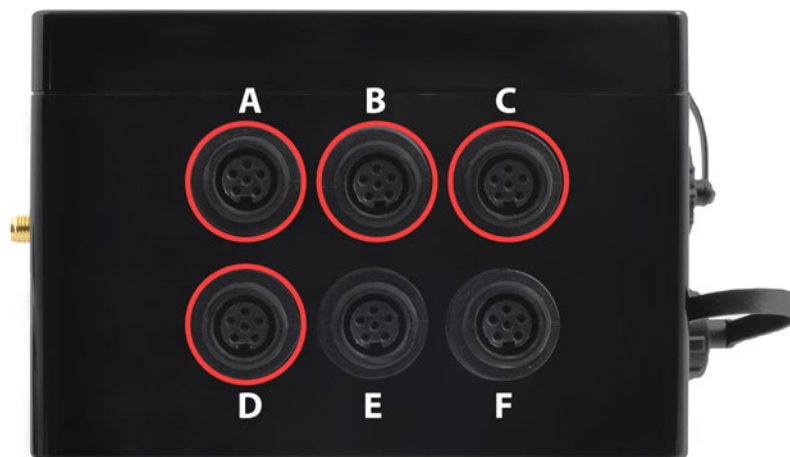

Figure: Available sockets for the 5TE sensor probe

4.10.4. Installation

The 5TE sensor can be inserted into growing media or soil, and it needs to be completely covered by soil.

It is important to avoid air gaps or extremely compact soil around the sensor. Do not install the 5TE sensor next to large metal objects, which can attenuate the sensor electromagnetic field and distort output readings.

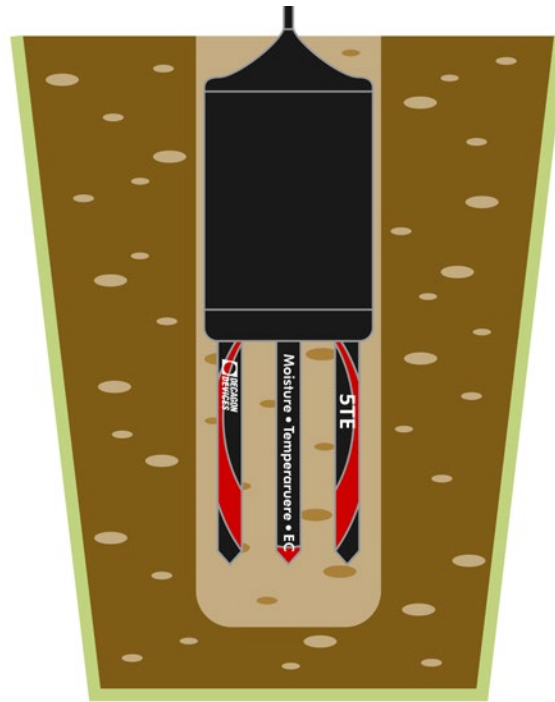

Figure: Water content, electrical conductivity, and temperature sensor installation

You can find the complete sensor manual on the manufacturer’s website.

4.10.5. Application examples

- Greenhouse substrate monitoring
- Irrigation management
- Salt management
- Fertilizer movement
- Modeling processes that are affected by temperature

4.10.6. Quality Assurance Certificate

Together with this sensor we provide a quality assurance certificate in which the manufacturer ensures that the sensor has passed the internal quality procedures.

4.11. Soil temperature and volumetric water content sensor probe (Decagon 5TM)

The Soil temperature and volumetric water content sensor probe (Decagon 5TM) sensor can measure volumetric water content and temperature of soil. The sensor uses an oscillator running at 70 MHz to measure the dielectric permittivity of soil to determine the water content (VWC). A thermistor in thermal contact with the sensor prongs provides the soil temperature.

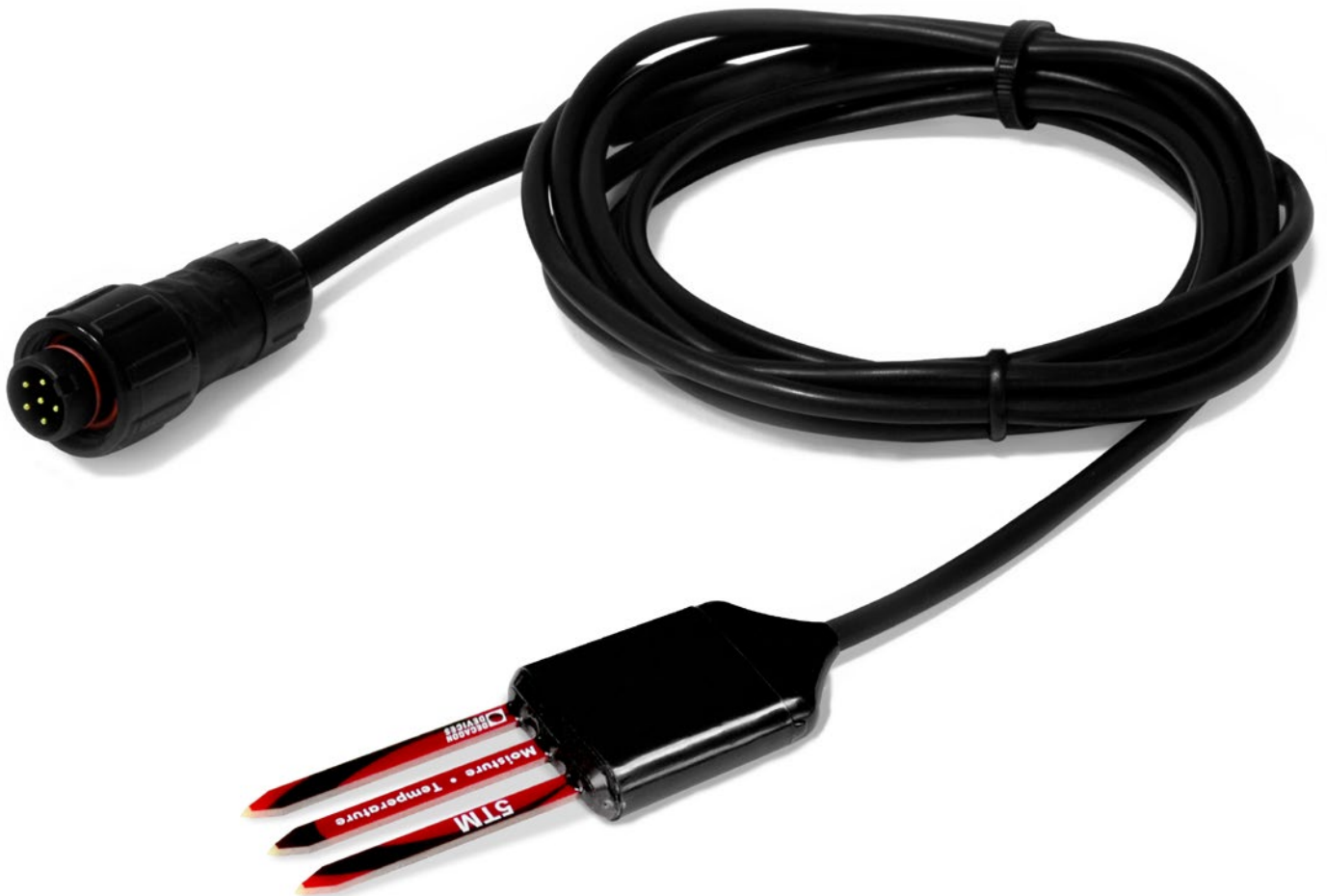

Figure: Soil temperature and volumetric water content sensor probe (Decagon 5TM)

4.11.1. Specifications

General specifications

- Operating temperature: -40 to 60 °C
- Dielectric measurement frequency: 70 MHz
- Measurement time: 150 ms
- Dimensions: 10 cm x 3.2 cm x 0.7 cm
- Prong length: 5.2 cm
- Cable length: 5 m

Volumetric water content

- Range: Apparent dielectric permittivity (ϵ_a): 1 (air) to 80 (water)
- Resolution:
 - 0.1 ϵ_a (unitless) from 1 to 20,
 - < 0.75 ϵ_a (unitless) from 20 to 80
 - 0.0008 m³/ m³ (0.08% VWC) from 0 to 50% VWC
- Accuracy: ϵ_a : $\pm 1 \epsilon_a$ (unitless) from 1 to 40 (soil range), $\pm 15\%$ from 40 to 80 (VWC)

Temperature

- Range: -40 to 60 °C
- Resolution: 0.1 °C
- Accuracy: ± 1 °C

4.11.2. Measurement process

The 5TM sensor provides a digital signal using the SDI-12 protocol.

Reading code:

```
{
  // 1. Declare an object for the sensor
  Decagon_5TM mySensor(AGR_XTR_SOCKET_A);

  // 2. Turn ON the sensor
  mySensor.ON();

  // 3. Read the sensor. Values stored in class variables
  // Check complete code example for details
  mySensor.read();

  // 4. Turn off the sensor
  mySensor.OFF();
}
```

Volumetric water content (VWC) calculation

The 5TM sensor provides the dielectric permittivity (ϵ_a) of the surrounding medium. The dielectric permittivity value must be converted in your code to your particular substrate volumetric water content by a calibration equation specific to the media you are working in.

The calibration equation for mineral soil (Topp equation) is:

$$\text{VWC}\left(\frac{\text{m}^3}{\text{m}^3}\right) = 4.3 \cdot 10^{-6} \epsilon_a^3 - 5.5 \cdot 10^{-4} \epsilon_a^2 + 2.92 \cdot 10^{-2} \epsilon_a - 5.3 \cdot 10^{-2}$$

The calibration equation for potting soil is:

$$VWC\left(\frac{m^3}{m^3}\right) = 2.25 \cdot 10^{-5} \epsilon_a^3 - 2.06 \cdot 10^{-3} \epsilon_a^2 + 7.24 \cdot 10^{-2} \epsilon_a - 0.247$$

The calibration equation for rockwool is:

$$VWC\left(\frac{m^3}{m^3}\right) = -1.68 \cdot 10^{-3} \epsilon_a^2 + 6.56 \cdot 10^{-2} \epsilon_a + 0.0266$$

The calibration equation for perlite is:

$$VWC\left(\frac{m^3}{m^3}\right) = -1.07 \cdot 10^{-3} \epsilon_a^2 + 5.25 \cdot 10^{-2} \epsilon_a - 0.0685$$

You can find a complete example code for reading this sensor probe and calculating VWC for mineral soil in the following link: <http://www.libelium.com/development/waspote/examples/ag-xtr-09-5TM-sensor-reading>

4.11.3. Socket

Connect the 5TM sensor probe to Plug & Sense! Smart Agriculture Xtreme in any of the sockets shown in the image below.

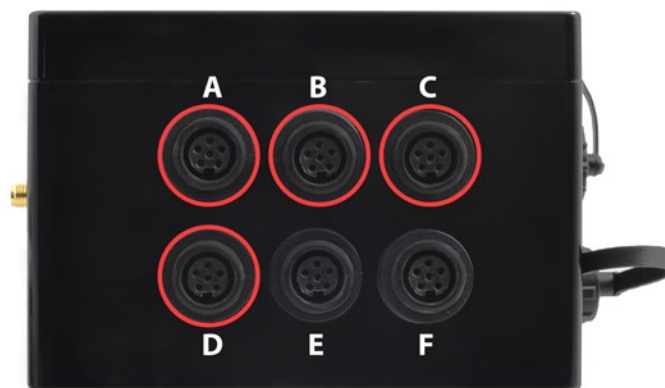

Figure: Available sockets for the 5TM sensor probe

4.11.4. Installation

The 5TM sensor can be inserted into growing media or soil, and it needs to be completely covered by soil.

It is important to avoid air gaps or extremely compact soil around the sensor. Do not install the 5TM sensor next to large metal objects, which can attenuate the sensor electromagnetic field and distort output readings.



Figure: 5TE sensor installation

You can find a complete example code for reading this sensor probe in the following link: <http://www.libelium.com/development/waspote/examples/ag-xtr-09-5TM-sensor-reading>

4.11.5. Application examples

- Soil water balance
- Irrigation management
- Modeling processes that are affected by temperature

4.11.6. Quality Assurance Certificate

Together with this sensor we provide a quality assurance certificate in which the manufacturer ensures that the sensor has passed the internal quality procedures.

4.12. Soil water potential sensor probe (Decagon MPS-6)

There are 2 basic parameters that describe the state of water in soil: one is soil water content, or the amount of water per unit of soil, and the other is soil water potential, or the energy state of water in the soil. Although water content is useful when trying to describe the water balance of a soil, i.e. how much water is moving in, out, or being stored, water potential is often preferred over water content because it determines how water moves in a soil or from the soil to the plant. In addition, you can use water potential to determine plant availability of water, schedule irrigation, or determine the mechanical stress state of soil.

The Soil water potential sensor probe (Decagon MPS-6) measures the water potential and temperature of a wide range of soil and other porous materials without user maintenance and factory calibration. Its extended range makes this sensor ideal for measuring the water potential in natural systems or other drier systems. The added temperature measurements can be used to determine approximate soil water potential in frozen soils.



Figure: Soil water potential sensor probe (Decagon MPS-6)

4.12.1. Specifications

General specifications

- Operating temperature: -40 to 60 °C (no water potential measurement below 0 °C)
- Operation humidity: 0 ~ 100% RH
- Dielectric measurement frequency: 70 MHz
- Measurement time: 150 ms
- Dimensions: 9.6 cm (L) x 3.5 cm (W) x 1.5 cm (D)
- Sensor diameter: 3.2 cm
- Cable length: 5 m

Water potential

- Range: -9 to -100,000 kPa (pF 1.96 to pF 6.01)
- Resolution: 0.1 kPa
- Accuracy: $\pm(10\%$ of reading + 2 kPa) from -9 to -100 kPa

Temperature

- Range: -40 to 60 °C
- Resolution: 0.1 °C
- Accuracy: ± 1 °C

4.12.2. Measurement process

The MPS-6 sensor provides a digital signal using the SDI-12 protocol.

Reading code:

```
{
  // 1. Declare an object for the sensor
  Decagon_MPS6 mySensor(AGR_XTR_SOCKET_A);

  // 2. Turn ON the sensor
  mySensor.ON();

  // 3. Read the sensor. Values stored in class variables
  // Check complete code example for details
  mySensor.read();

  // 4. Turn off the sensor
  mySensor.OFF();
}
```

You can find a complete example code for reading this sensor probe in the following link: <http://www.libelium.com/development/waspote/examples/ag-xtr-10-MPS6-sensor-reading>

4.12.3. Socket

Connect the MPS-6 sensor probe to Plug & Sense! Smart Agriculture Xtreme in any of the sockets shown in the image below.

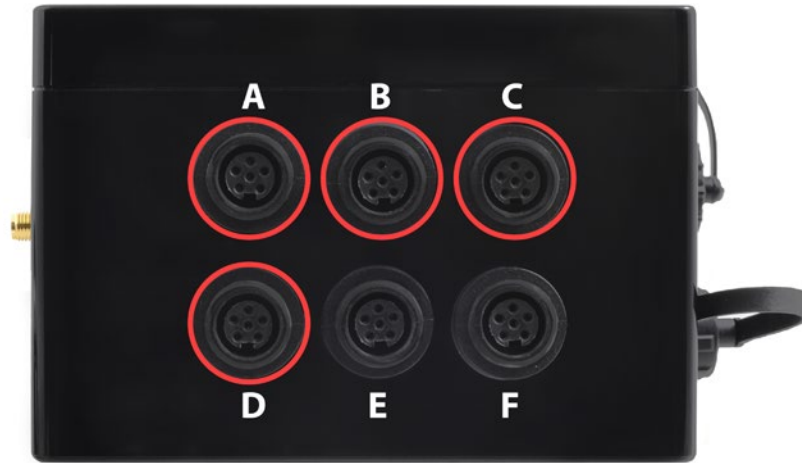

Figure: Available sockets for the MPS-6 sensor probe

4.12.4. Installation

The MPS-6 sensor needs good hydraulic contact with the surrounding soil. The best method for installing the sensor is to take some native soil, wet it, and pack it in a ball around the entire sensor, making sure that the moist soil is in contact with all surfaces of the ceramic in the sensor. Then place the sensor into the soil at the desired depth.

After installing the sensor, the hole that was excavated to bury the sensor at depth should be back-filled with care taken to pack the soil back to its native bulk density. Leave at least 15 centimeters of sensor cable beneath the soil before bringing the cable to the surface.

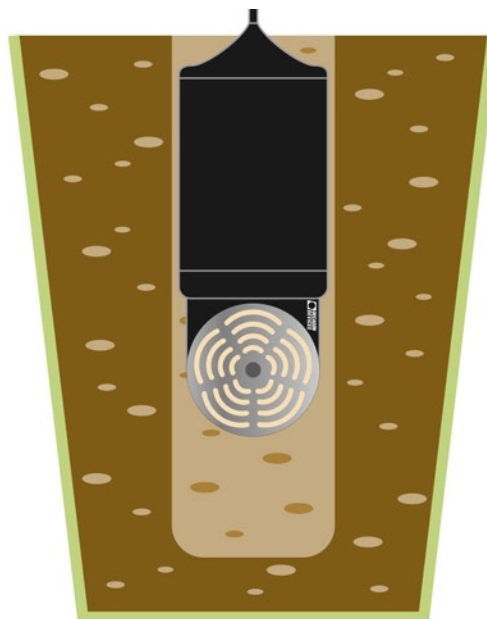

Figure: Water potential and temperature sensor installation

You can find the complete sensor manual on the manufacturer's website.

4.12.5. Application examples

- Deficit irrigation monitoring and control
- Water potential monitoring in the vadose zone
- Crop stress
- Waste water drainage studies
- Plant water availability

4.12.6. Quality Assurance Certificate

Together with this sensor we provide a quality assurance certificate in which the manufacturer ensures that the sensor has passed the internal quality procedures.

4.13. Vapor pressure, temperature, barometric pressure and relative humidity sensor (Decagon VP-4)

The VP-4 sensor probe is an accurate tool to measure air temperature, relative humidity (RH), vapor pressure, and barometric pressure in soil and in air. A microprocessor within the sensor calculates vapor pressure from the RH and temperature measurements. The sensor uses a sensor chip to measure both air temperature and RH and a secondary chip to measure barometric pressure.

Despite this sensor can be installed in dry soils with a good performance, it is not recommended for saturated soils. The humidity measurements could saturate and could give a drift. Moreover, if the soil is completely saturated, it will not make sense to measure barometric pressure because there will not be air in the soil.



Figure: Vapor pressure, humidity, temperature and pressure in soil and air sensor probe (Decagon VP-4)



Figure: VP-4 sensor inside radiation shield

4.13.1. Specifications

General specifications

- Operating temperature: -40 to 80 °C
- Measurement time: 300 ms
- Dimensions: 1.96 cm (dia) x 5.4 cm (h)
- Cable length: 5 m

Vapor pressure

- Range: 0 to 47 kPa
- Resolution: 0.001 kPa
- Accuracy: see diagram below

Vapor Pressure Accuracy [%RH]

	100%	±0.05	±0.09	±0.16	±0.29	±0.49	±0.81	±1.30	±2.62	±6.32
	95%	±0.05	±0.09	±0.14	±0.24	±0.41	±0.68	±1.08	±2.26	±5.27
	90%	±0.05	±0.07	±0.09	±0.15	±0.33	±0.54	±1.06	±2.23	±5.20
	85%	±0.05	±0.07	±0.08	±0.15	±0.33	±0.53	±1.05	±2.19	±5.13
	80%	±0.04	±0.07	±0.08	±0.15	±0.32	±0.53	±0.83	±1.84	±4.07
	75%	±0.04	±0.07	±0.08	±0.14	±0.31	±0.52	±0.82	±1.80	±4.00
	70%	±0.04	±0.07	±0.08	±0.14	±0.31	±0.51	±0.81	±1.77	±3.97
	65%	±0.04	±0.07	±0.08	±0.13	±0.30	±0.50	±0.79	±1.73	±3.86
	60%	±0.04	±0.05	±0.07	±0.13	±0.22	±0.36	±0.57	±1.38	±3.30
	55%	±0.04	±0.04	±0.07	±0.13	±0.22	±0.35	±0.56	±1.34	±3.23
	50%	±0.03	±0.04	±0.07	±0.12	±0.21	±0.34	±0.55	±1.31	±3.16
	45%	±0.03	±0.04	±0.07	±0.12	±0.20	±0.33	±0.53	±1.27	±2.60
	40%	±0.03	±0.03	±0.07	±0.12	±0.20	±0.33	±0.52	±1.24	±2.53
	35%	±0.03	±0.05	±0.06	±0.11	±0.19	±0.32	±0.50	±1.20	±2.46
	30%	±0.03	±0.05	±0.06	±0.11	±0.19	±0.31	±0.49	±1.17	±2.39
	25%	±0.03	±0.04	±0.06	±0.10	±0.18	±0.30	±0.48	±1.14	±2.32
	20%	±0.03	±0.06	±0.06	±0.10	±0.25	±0.41	±0.67	±1.10	±2.25
	15%	±0.03	±0.05	±0.05	±0.10	±0.24	±0.40	±0.85	±1.39	±2.67
	10%	±0.05	±0.07	±0.08	±0.14	±0.31	±0.52	±0.84	±1.67	±4.08
	5%	±0.05	±0.10	±0.12	±0.22	±0.38	±0.64	±1.03	±1.96	±5.00
	0%	±0.08	±0.15	±0.12	±0.22	±0.45	±0.75	±1.22	±3.21	±5.92
		0°C	10°C	20°C	30°C	40°C	50°C	60°C	70°C	80°C

Figure: Vapor pressure accuracy chart

Temperature

- Range: -40 to 80 °C
- Resolution: 0.1 °C
- Equilibration time: < 400 s
- Long term drift: < 0.04 °C/year typical
- Accuracy: see diagram below

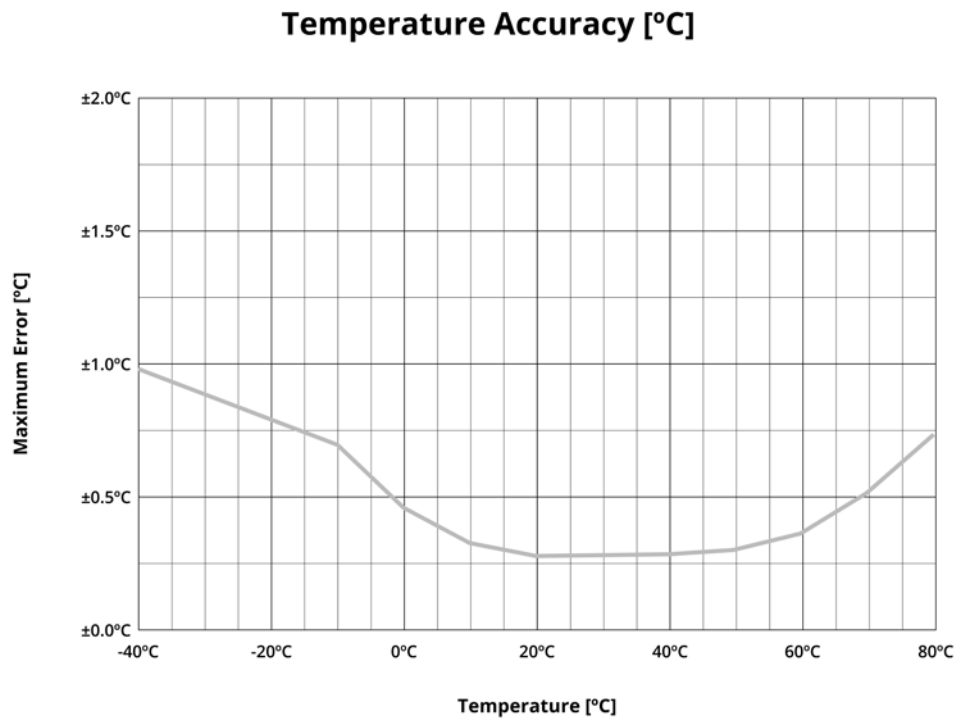

Figure: Temperature accuracy chart

Barometric pressure

- Range: 49 to 109 kPa
- Resolution: 0.01 kPa
- Accuracy: 0.4 kPa

Relative humidity

- Range: 0 to 100% RH
- Resolution: 0.1% RH
- Equilibration time: <40 s
- Hysteresis: <1% RH typical
- Long term drift: <0.5% RH/year typical
- Accuracy: see diagram below

Humidity Accuracy [%RH]

	100%	±5%	±5%	±5%	±5%	±5%	±5%	±5%	±6%	±10%
	95%	±5%	±5%	±4%	±4%	±4%	±4%	±4%	±5%	±8%
	90%	±5%	±4%	±2%	±2%	±3%	±3%	±4%	±5%	±8%
	85%	±5%	±4%	±2%	±2%	±3%	±3%	±4%	±5%	±8%
	80%	±4%	±4%	±2%	±2%	±3%	±3%	±3%	±4%	±6%
	75%	±4%	±4%	±2%	±2%	±3%	±3%	±3%	±4%	±6%
	70%	±4%	±4%	±2%	±2%	±3%	±3%	±3%	±4%	±6%
	65%	±4%	±4%	±2%	±2%	±3%	±3%	±3%	±4%	±6%
	60%	±4%	±3%	±2%	±2%	±2%	±2%	±2%	±3%	±5%
	55%	±4%	±2%	±2%	±2%	±2%	±2%	±2%	±3%	±5%
	50%	±4%	±2%	±2%	±2%	±2%	±2%	±2%	±3%	±5%
	45%	±4%	±2%	±2%	±2%	±2%	±2%	±2%	±3%	±4%
	40%	±4%	±2%	±2%	±2%	±2%	±2%	±2%	±3%	±4%
	35%	±4%	±3%	±2%	±2%	±2%	±2%	±2%	±3%	±4%
	30%	±4%	±3%	±2%	±2%	±2%	±2%	±2%	±3%	±4%
	25%	±4%	±3%	±2%	±2%	±2%	±2%	±2%	±3%	±4%
	20%	±4%	±4%	±2%	±2%	±3%	±3%	±3%	±3%	±4%
	15%	±5%	±4%	±2%	±2%	±3%	±3%	±4%	±4%	±5%
	10%	±8%	±5%	±3%	±3%	±4%	±4%	±4%	±5%	±8%
	5%	±8%	±8%	±5%	±5%	±5%	±5%	±5%	±6%	±10%
	0%	±12%	±12%	±5%	±5%	±6%	±6%	±6%	±10%	±12%
		0°C	10°C	20°C	30°C	40°C	50°C	60°C	70°C	80°C

Figure: Humidity accuracy chart

4.13.2. Measurement process

The VP-4 sensor provides a digital signal using the SDI-12 protocol.

Reading code:

```

{
  // 1. Declare an object for the sensor
  Decagon_VP4 mySensor(AGR_XTR_SOCKET_A);

  // 2. Turn ON the sensor
  mySensor.ON();

  // 3. Read the sensor. Values stored in class variables
  // Check complete code example for details
  mySensor.read();

  // 4. Turn off the sensor
  mySensor.OFF();
}

```

You can find a complete example code for reading this sensor probe in the following link: http://www.libelium.com/development/waspote/examples/ag-xtr-11-VP4-sensor-reading_

4.13.3. Socket

Connect the VP-4 sensor probe to Plug & Sense! Smart Agriculture Xtreme in any of the sockets shown in the image below.

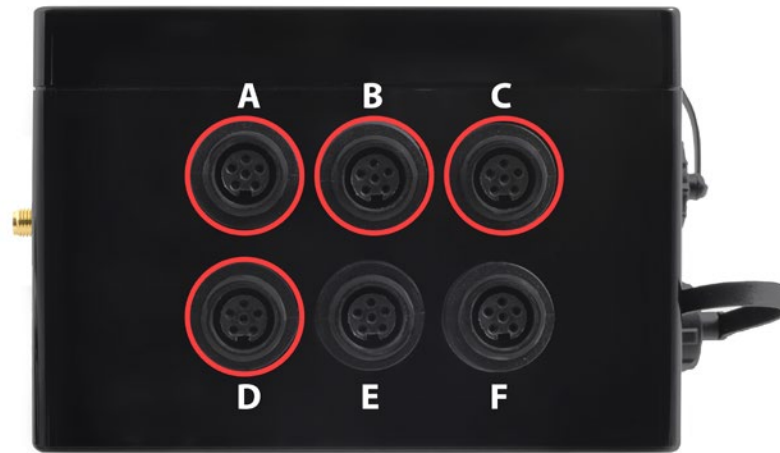

Figure: Available sockets for the VP-4 sensor probe

4.13.4. Installation

The humidity sensor needs to be at air temperature in order to get accurate representation of the atmospheric humidity, for this reason in most outdoor uses it is necessary to house the sensor inside a radiation shield with adequate air flow. This allows the sensor to be in equilibrium with air temperature. The radiation shield comes with a mounting bracket and 7 discs that prevent direct sunlight from coming into contact with the sensor.



Figure: Inserting the VP-4 sensor in the radiation shield

The radiation shield with the sensor can be mounted on the desired place. Fasten the sensor cord to the mounting post to avoid that the weight of the cable pulls out the sensor.

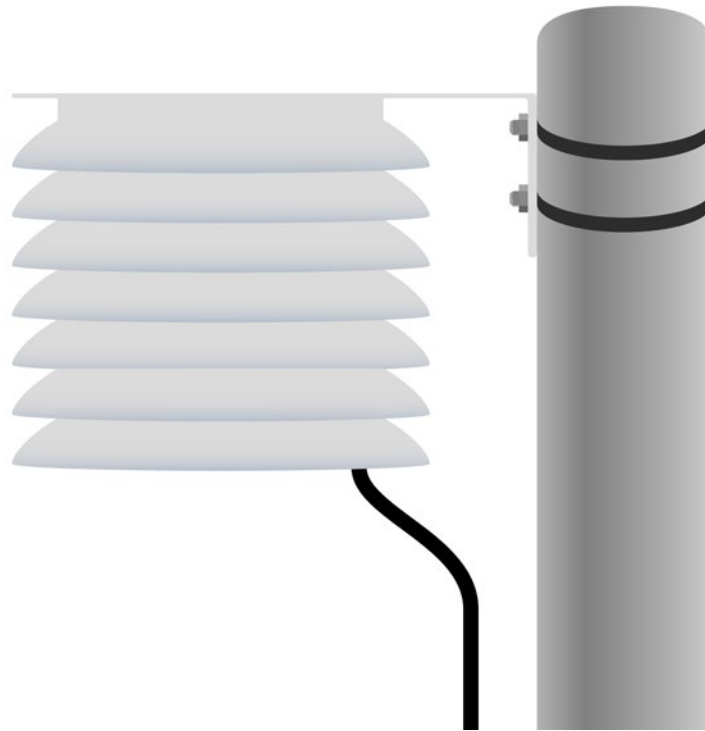

Figure: The VP-4 sensor installation

You can find the complete sensor manual on the manufacturer's website.

4.13.5. Application examples

- Greenhouse and canopy monitoring
- Reference evapotranspiration calculations
- Routine weather monitoring
- Building humidity monitoring
- Mold remediation
- Modeling processes that are affected by vapor pressure or humidity

4.13.6. Quality Assurance Certificate

Together with this sensor we provide a quality assurance certificate in which the manufacturer ensures that the sensor has passed the internal quality procedures.

4.14. Leaf wetness Phytos 31 sensor probe (Decagon Phytos 31)

The Leaf wetness Phytos 31 sensor probe (Decagon Phytos 31) measures leaf surface wetness by measuring the dielectric constant of the sensor's upper surface. This sensor has very high resolution, which gives you the ability to detect very small amounts of water (or ice) on the sensor surface. Water on the sensor surface does not need to bridge electrical traces to be detected, as is common with resistance-based surface wetness sensors.



Figure: Leaf wetness Phytos 31 sensor probe (Decagon Phytos-31)

4.14.1. Specifications

- **Operating temperature:** -20 to 60 °C
- **Measurement time:** 10 ms
- **Probe dimensions:** 11.2 cm x 5.8 cm x .075 cm
- **Cable length:** 5 m

4.14.2. Measurement process

The Phytos 31 sensor probe provides an analog signal.

Reading code:

```

{
  // 1. Declare an object for the sensor
  leafWetness mySensor();

  // 2. Turn ON the sensor
  mySensor.ON();

  // 3. Read the sensor. Values stored in class variables
  // Check complete code example for details
  mySensor.read();

  // 4. Turn off the sensor
  mySensor.OFF();
}

```

You can find a complete example code for reading this sensor probe in the following link: <http://www.libelium.com/development/waspmote/examples/ag-xtr-12-phytos31-sensor-reading>

4.14.3. Socket

Connect the Phytos 31 sensor probe to Plug & Sense! Smart Agriculture Xtreme in any of the sockets shown in the image below.



Figure: Available sockets for the Phytos 31 sensor probe

4.14.4. Installation

The Leaf wetness sensor is designed with leaf shape in order to be mounted next to the canopy or on a weather station pole. The 2 holes in the black part of the sensor can be used to fix the sensor with bolts or zip ties. Unlike other leaf wetness sensors, this sensor does not require to be installed at a specific inclination (45°, for example). Besides, the plastic surface of this sensor makes it more resistant to oxidation than traditional leaf wetness sensors with exposed electric traces.



Figure: Phytos 31 sensor installation

You can find the complete sensor manual on the manufacturer's website.

4.14.5. Application examples

- Decision of usage for crop fungicides
- Predict crop diseases or infections

4.14.6. Quality Assurance Certificate

Together with this sensor we provide a quality assurance certificate in which the manufacturer ensures that the sensor has passed the internal quality procedures.

4.15. Dendrometer sensor probes for Smart Agriculture Xtreme (Ecomatik DC2, DD-S and DF)

Dendrometers are highly precise instruments for the continuous measurement of changes in plant diameter (i.e. growth dynamic, diurnal diameter changes). Dendrometer signals document the response of plants to their environment in high temporal resolution.

This type of sensors do not measure the total diameter of the trunk or fruit, but the micro variations in diameter. That is a great tool to study how well the plant grows, absorbs and transpires water, its hydrological stress, possible diseases, etc.



Figure: Dendrometer sensor (Ecomatik DF)

4.15.1. Ecomatik DC2 specifications (Trunk diameter)

- **Operation temperature:** -30 ~ 40 °C
- **Operation humidity:** 0 ~ 100% RH
- **Trunk/branch diameter:** From 2 cm
- **Accuracy:** $\pm 2 \mu\text{m}$
- **Temperature coefficient:** $< 0.1 \mu\text{m/K}$
- **Linearity:** $< 2\%$
- **Cable length:** 2 m
- **Output range:** 0 ~ 20 k Ω
- **Range of the sensor:** Function of the size of the tree:

Tree Diameter (cm)	Measuring range in circumference (mm)	Measuring range in diameter (mm)
10	31.25	9.94
40	22.99	7.31
100	16.58	5.27

4.15.2. Ecomatik DD-S specifications (Stem diameter)

- **Operation temperature:** -30 ~ 40 °C
- **Operation humidity:** 0 ~ 100% RH
- **Stem/branch diameter:** 0 ~ 20 cm
- **Range of the sensor:** 11 mm
- **Output range:** 0 ~ 20 kΩ
- **Accuracy:** ±2 μm
- **Temperature coefficient:** <0.1 μm/K
- **Cable length:** 2 m

4.15.3. Ecomatik DF specifications (Fruit diameter)

- **Operation temperature:** -30 ~ 40 °C
- **Operation humidity:** 0 ~ 100% RH
- **Fruit diameter:** 0 ~ 11 cm
- **Range of the sensor:** 11 mm
- **Output range:** 0 ~ 20 kΩ
- **Accuracy:** ±2 μm
- **Temperature coefficient:** <0.1 μm/K
- **Cable length:** 2 m

4.15.4. Measurement process

The operation of the 3 Ecomatik dendrometers, DC2, DD-S and DF, is based on the variation of an internal resistance with the pressure that the growing of the trunk, stem, branch or fruit exerts on the sensor. The Ecomatik dendrometers provide an analog output signal.

Reading code:

```
{
  // 1. Declare an object for the sensor
  dendrometer mySensor(DENDRO_DD);

  // 2. Turn ON the sensor
  mySensor.ON();

  // 3. Read the sensor. Values stored in class variables
  // Check complete code example for details
  mySensor.read();

  // 4. Turn off the sensor
  mySensor.OFF();
}
```

You can find a complete example code for reading this sensor probe in the following link: <http://www.libelium.com/development/waspote/examples/ag-xtr-13-dendrometer-sensor-reading>

4.15.5. Socket

Connect the Ecomatik dendrometer sensor probe to Plug & Sense! Smart Agriculture Xtreme in any of the sockets shown in the image below.

Note: This sensor has a specific wiring for the Plug & Sense! Smart Agriculture Xtreme model, so it is not compatible with other Plug & Sense! models and vice versa. Refer to our Sales department for more information.



Figure: Available sockets for Ecomatik dendrometers sensor probes

4.15.6. Installation

There are three different sensor models focused on different elements to be measured. Place the sensor as you can see in the following images.



Figure: Ecomatik DC2 sensor for trunk diameter



Figure: Ecomatik DD-S sensor for stem diameter



Figure: Ecomatik DF sensor for fruit diameter

4.15.7. Application examples

- Monitoring of growth processes of plants
- Examination of the influence of environmental factors on plant growth
- Precise dating of beginning and end of the growing season

4.16. Weather station sensor probes (Gill Instruments MaxiMet series)

The Plug & Sense! Smart Agriculture Xtreme model offers the possibility of connecting any of the MaxiMet weather stations provided by Gill Instruments.

The MaxiMet series offers a compact solution for weather forecast. The user can choose easily the best configuration thanks to the modularity that they offer, keeping the robustness, easy installation and low maintenance features. In other words, any of the different weather sensors can be combined in a custom model.

Parameters related with wind, precipitation, solar radiation, dew point, air temperature, air humidity or atmospheric air pressure can be measured with these weather station probes.

In the next subsections, all the available models are described briefly to allow the user selecting the best for each application. However, a feature table is also provided below:

Weather station	Wind and compass	Precipitation	Temperature, relative humidity and pressure	Solar radiation	GPS
GMX-100 (PO)		X (Optical)			
GMX-101 (R)				X	
GMX-200 (W)	X				Optional
GMX-240 (PO-W)	X	X (Optical)			Optional
GMX-300 (T-H-AP)			X		
GMX-301 (T-H-AP-R)			X	X	
GMX-400 (PO-T-H-AP)		X (Optical)	X		
GMX-500 (W-T-H-AP)	X		X		Optional
GMX-501 (W-T-H-AP-R)	X		X	X	Optional
GMX-531 (W-PT-T-H-AP-R)	X	X (Tipping bucket)	X	X	Optional
GMX-541 (W-PO-T-H-AP-R)	X	X (Optical)	X	X	Optional
GMX-550 (W-x-T-H-AP)	X	Optional (Tipping bucket)	X		Optional
GMX-551 (W-x-T-H-AP-R)	X	Optional (Tipping bucket)	X	X	Optional
GMX-600 (W-PO-T-H-AP)	X	X (Optical)	X		Optional

According to Libelium's nomenclature:

- PO: Includes a Precipitation sensor (Optical type)
- PT: Includes a Precipitation sensor (Tipping bucket type)
- x: This item accepts a Precipitation sensor (tipping bucket type), needs to be ordered apart
- W: Includes a Wind sensor
- T-H-AP: Includes air Temperature, air Humidity and Atmospheric air Pressure sensors
- R: Includes a Radiation sensor

As seen, the weather stations capable of metering wind, can accept a GPS accessory (available on demand, needs to be ordered specially).

The precipitation parameter can be measured with 2 different sensors: the optical one and the traditional tipping bucket (Gill's Kalyx rain gauge). The tipping bucket is included by default in the GMX-531, but it needs to be ordered as an accessory for the GMX-550 and GMX-551 (available on demand).

4.16.1. MaxiMet GMX-100 (PO) sensor probe

The MaxiMet GMX-100 sensor probe provides accurate information about precipitation (optical method).

An integrated optical rain gauge that senses water hitting its outside surface provides measurements based on the size and number of drops.

The optical rain gauge has no moving parts so possible mechanical problems are avoided.



Figure: MaxiMet GMX-100 sensor probe

4.16.2. MaxiMet GMX-101 (R) sensor probe

The MaxiMet GMX-101 sensor probe provides accurate information about solar radiation.

An integrated pyranometer, protected by a single glass, measures the solar radiation. In addition, an inclinometer is also included to allow a precise installation.



Figure: MaxiMet GMX-101 sensor probe

4.16.3. MaxiMet GMX-200 (W) sensor probe

The MaxiMet GMX-200 sensor probe provides accurate information about wind.

Three ultrasonic sensors provide wind speed and direction measurements and the addition of an electronic compass provides apparent wind measurement. Average speed and direction together with WMO averages and gust data are also provided.



Figure: MaxiMet GMX-200 sensor probe

In addition, this model has a compass and an optional GPS.

4.16.4. MaxiMet GMX-240 (W-PO) sensor probe

The MaxiMet GMX-240 is a weather station that provides accurate meteorological information about wind and precipitation (optical method).

Three ultrasonic sensors provide wind speed and direction measurements and the addition of an electronic compass provides apparent wind measurement. Average speed and direction together with WMO averages and gust data are also provided.

An integrated optical rain gauge that senses water hitting its outside surface provides measurements based on the size and number of drops.

The optical rain gauge and the wind ultrasonic sensors have no moving parts so possible mechanical problems are avoided.



Figure: MaxiMet GMX-240 sensor probe

4.16.5. MaxiMet GMX-300 (T-H-AP) sensor probe

The MaxiMet GMX-300 sensor probe provides accurate information about air temperature, air humidity and atmospheric air pressure.

This model is basically a solar shield with no moving parts which allows high performance over large time periods.



Figure: MaxiMet GMX-300 sensor probe

4.16.6. MaxiMet GMX-301 (T-H-AP-R) sensor probe

The MaxiMet GMX-301 sensor probe provides accurate information about air temperature, air humidity, atmospheric air pressure and solar radiation.

This model is basically a solar shield with no moving parts which allows high performance over large time periods. On the top of the solar shield, an integrated pyranometer protected by a single glass measures the solar radiation. In addition, an inclinometer is also included to allow a precise installation.



Figure: MaxiMet GMX-301 sensor probe

4.16.7. MaxiMet GMX-400 (PO-T-H-AP) sensor probe

The MaxiMet GMX-400 sensor probe provides accurate information about precipitation (optical method), air temperature, air humidity and atmospheric air pressure.

This model is basically a solar shield with no moving parts which allows high performance over large time periods. On the top of the solar shield, an integrated optical rain gauge senses water hitting its outside surface, providing measurements based on the size and number of drops.



Figure: MaxiMet GMX-400 sensor probe

4.16.8. MaxiMet GMX-500 (W-T-H-AP) sensor probe

The MaxiMet GMX-500 sensor probe provides accurate information about wind, air temperature, air humidity and atmospheric air pressure.

This model is basically a solar shield with no moving parts which allows high performance over large time periods. On the top of the solar shield, three ultrasonic sensors are placed to provide wind speed and direction measurements. Besides, an electronic compass provides apparent wind measurement. Average speed and direction together with WMO averages and gust data are also provided.



Figure: MaxiMet GMX-500 sensor probe

4.16.9. MaxiMet GMX-501 (W-T-H-AP-R) sensor probe

The MaxiMet GMX-501 sensor probe provides accurate information about wind, air temperature, air humidity, atmospheric air pressure and solar radiation.

This model is basically a solar shield with no moving parts which allows high performance over large time periods. On the top of the solar shield, three ultrasonic sensors are placed to provide wind speed and direction measurements. Besides, an electronic compass provides apparent wind measurement. Average speed and direction together with WMO averages and gust data are also provided. Additionally, an integrated pyranometer protected by a single glass measures the solar radiation. Finally, an inclinometer is also included to allow a precise installation.



Figure: MaxiMet GMX-501 sensor probe

4.16.10. MaxiMet GMX-531 (W-PT-T-H-AP-R) sensor probe

The MaxiMet GMX-531 sensor probe provides accurate information about wind, precipitation (tipping bucket method), air temperature, air humidity, atmospheric air pressure and solar radiation.

This model is basically a solar shield with no moving parts which allows high performance over large time periods. On the top of the solar shield, three ultrasonic sensors are placed to provide wind speed and direction measurements. Besides, an electronic compass provides apparent wind measurement. Average speed and direction together with WMO averages and gust data are also provided. Additionally, an integrated pyranometer protected by a single glass measures the solar radiation. Finally, an inclinometer is also included to allow a precise installation.

On top of that, a tipping bucket rain gauge is provided to measure precipitation, with excellent performance in tropical or heavy precipitation locations. The Kalyx rain gauge is connected using a 20 m cable.



Figure: MaxiMet GMX-531 sensor probe

4.16.11. MaxiMet GMX-541 (W-PO-T-H-AP-R) sensor probe

The MaxiMet GMX-541 sensor probe provides accurate information about wind, precipitation (optical method), air temperature, air humidity, atmospheric air pressure and solar radiation.

This model is basically a solar shield with no moving parts which allows high performance over large time periods. On the top of the solar shield, three ultrasonic sensors are placed to provide wind speed and direction measurements. Besides, an electronic compass provides apparent wind measurement. Average speed and direction together with WMO averages and gust data are also provided. Additionally, an integrated pyranometer protected by a single glass measures the solar radiation. Finally, an inclinometer is also included to allow a precise installation.



Figure: MaxiMet GMX-541 sensor probe

4.16.12. MaxiMet GMX-550 (W-x-T-H-AP) sensor probe

The MaxiMet GMX-550 sensor probe provides accurate information about wind, precipitation (with an accessory), air temperature, air humidity and atmospheric air pressure.

This model is basically a solar shield with no moving parts which allows high performance over large time periods. On the top of the solar shield, three ultrasonic sensors are placed to provide wind speed and direction measurements. Besides, an electronic compass provides apparent wind measurement. Average speed and direction together with WMO averages and gust data are also provided. Finally, an inclinometer is also included to allow a precise installation.

On top of that, an integrated connector allows the user to connect a tipping bucket rain gauge to measure precipitation.



Figure: MaxiMet GMX-550 sensor probe

4.16.13. MaxiMet GMX-551 (W-x-T-H-AP-R) sensor probe

The MaxiMet GMX-551 sensor probe provides accurate information about wind, precipitation (with an accessory), air temperature, air humidity, atmospheric air pressure and solar radiation.

This model is basically a solar shield with no moving parts which allows high performance over large time periods. On the top of the solar shield, three ultrasonic sensors are placed to provide wind speed and direction measurements. Besides, an electronic compass provides apparent wind measurement. Average speed and direction together with WMO averages and gust data are also provided. Additionally, an integrated pyranometer protected by a single glass measures the solar radiation. Finally, an inclinometer is also included to allow a precise installation.

On top of that, an integrated connector allows the user to connect a tipping bucket rain gauge to measure precipitation.

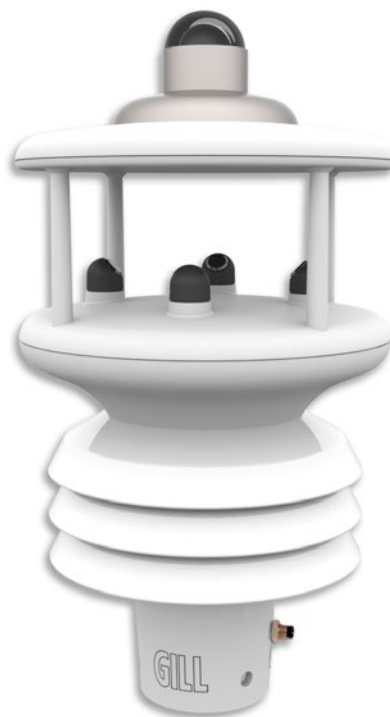

Figure: MaxiMet GMX-551 sensor probe

4.16.14. MaxiMet GMX-600 (W-PO-T-H-AP) sensor probe

The MaxiMet GMX-600 sensor probe provides accurate information about wind, precipitation (optical method), air temperature, air humidity and atmospheric air pressure.

This model is basically a solar shield with no moving parts which allows high performance over large time periods. On the top of the solar shield, three ultrasonic sensors are placed to provide wind speed and direction measurements. Besides, an electronic compass provides apparent wind measurement. Average speed and direction together with WMO averages and gust data are also provided. Moreover, an integrated optical rain gauge senses water hitting its outside surface, providing measurements based on the size and number of drops. Finally, an inclinometer is also included to allow a precise installation.

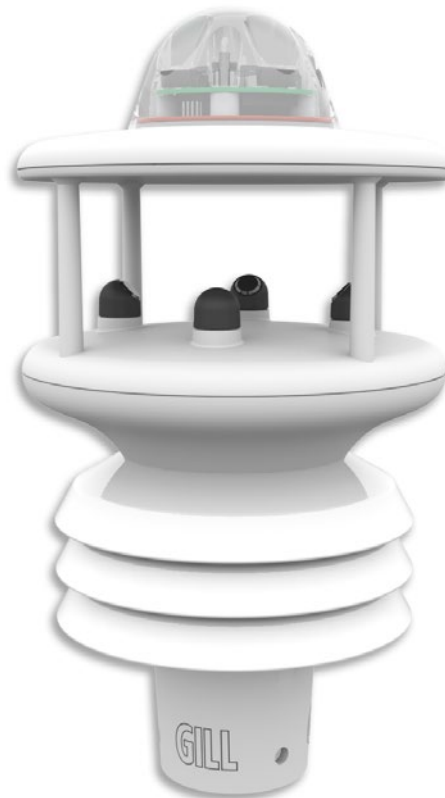

Figure: MaxiMet GMX-600 sensor probe

4.16.15. Specifications for each weather station sensor

General specifications

- Operating temperature: -40 to 70 °C
- Operation humidity: 0 ~ 100% RH
- Weight (approximate, depends on models): 0.5 Kg
- Dimensions (approximate, depends on models): 141 x 209.5 mm
- Protection Class: IP66

Wind speed

- Range: 0.01m/s to 60m/s
- Accuracy: $\pm 3\%$ to 40m/s; $\pm 5\%$ above 40 and up to 60m/s
- Resolution: 0.01 m/s
- Threshold: 0.01 m/s

Wind direction

- Range: 0-359°
- Accuracy: $\pm 3^\circ$ to 40m/s; $\pm 5^\circ$ above 40 and up to 60m/s
- Resolution: 1°
- Starting threshold: 0.05 m/s

Compass

- Range: 0-359°
- Accuracy: $\pm 3^\circ$
- Resolution: 1°

Precipitation: optical method

- Range: 0 to 300 mm/h
- Precipitation resolution: 0.2mm
- Repeatability: 3%

Precipitation: mechanical, tipping bucket method (Kalyx rain gauge)

- Range: 0-1000 mm/hr
- Precipitation resolution: 0.2 mm
- Accuracy: 2%

Air temperature and dew point

- Range: -40 °C to +70 °C
- Resolution: 0.1 °C
- Accuracy: ± 0.3 °C @ 20 °C

Air humidity

- Range: 0 - 100%
- Resolution: 1%
- Accuracy: $\pm 2\%$ @ 20 °C (10%-90% RH)

Atmospheric air pressure

- Range: 300 to 1100 hPa
- Resolution: 0.1 hPa
- Accuracy: ± 0.5 hPa @ 25 °C

Global solar radiation

- Wavelength sensitivity: 300 to 3000 nm
- Range: 0 to 1600 W/m²
- Resolution: 1 W/m²
- DIN standard: ISO 9060 Second Class

4.16.16. Measurement process

The MaxiMet weather stations provide a digital signal using the RS-485 protocol. The same code can be used to read all models. Nevertheless, the obtained parameters will be different.

Reading code:

```
{
  // 1. Declare an object for the sensor
  weatherStation mySensor;

  // 2. Turn ON the sensor
  mySensor.ON();
}

// main loop
{
  // 3. Read the sensor. Values stored in class variables
  // Check complete code example for details
  mySensor.read();

  //(...)
}
```

You can find a complete example code for reading this sensor probe in the following link: <http://www.libelium.com/development/waspote/examples/ag-xtr-15-GMX240-sensor-reading>

4.16.17. Socket

Connect the weather station sensor probes to Plug & Sense! Smart Agriculture Xtreme in any of the sockets shown in the image below.

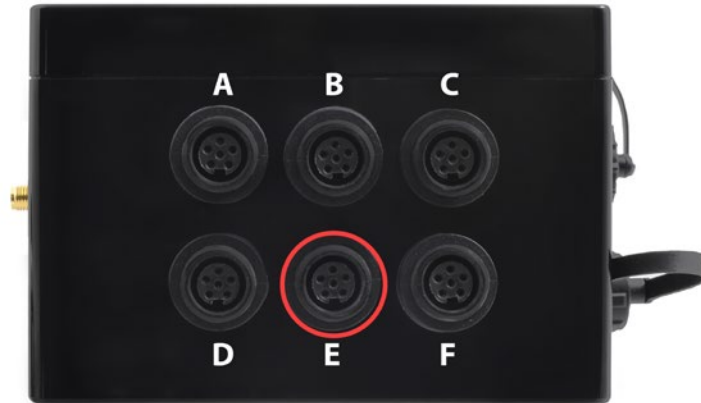

Figure: Available sockets for the weather station sensor probes

4.16.18. Installation

First, it is necessary to connect the cable in the bottom connector of the weather station.



Figure: Weather station bottom connector detail



Figure: Weather station cable connection

To make this connection correctly, it is necessary to insert the connector following the notches shown in the following image.



Figure: Weather station notches detail

It includes bolt fittings for securing the unit to a vertical pipe. Use a support tube of diameter 44.45 mm, 3 mm of wall thickness and 3 equidistant M5 holes.

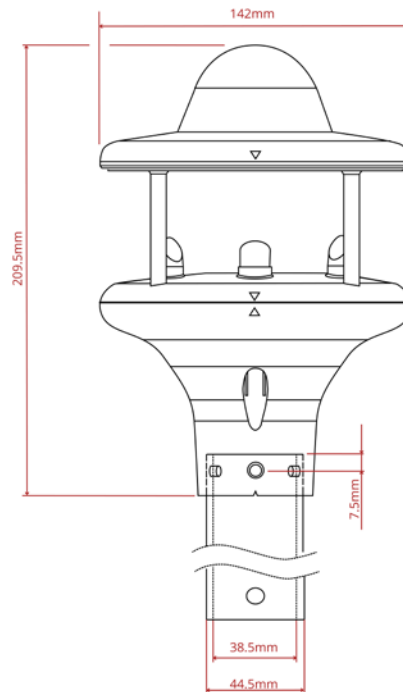

Figure: Aproximated weather station dimensions for GMX-240

It is recommendable to use a mast for the weather station installation. The optical rain gauge on the top must be facing the sky to measure precipitation correctly. Fix the weather station to the mast with 3 M5 bolts and nuts.



Figure: Weather station installation on a pole



Figure: Weather station fixed in a pole

For the correct measurement of the wind direction it is necessary to install the weather station correctly aligned. In order to do this, check that the north alignment pointers are correctly oriented to the north. Besides, select the location trying to maximize the natural wind flow through the sensor. Wind sensors should not be installed next to any obstacles like buildings, walls, plants, enclosures or objects that might affect the air flow.

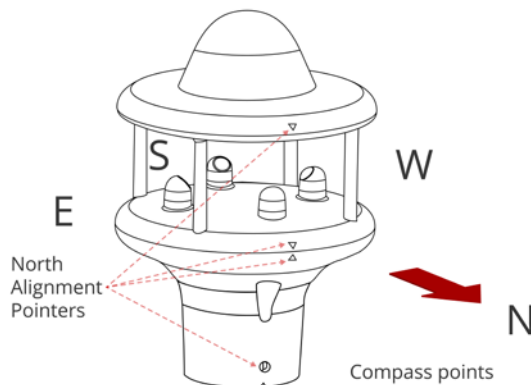

Figure: Weather station north alignment

Finally, the weather station requires continuous measures to obtain certain average values, so the energy consumption of this sensor may be considerable depending the application. That is specially true to weather

stations which measure fast-changing parameters, like wind or precipitation. Because of that, it is recommended to add external power to some Plug & Sense! Smart Agriculture Xtreme models with a weather station.

When the weather station is powered, it automatically senses weather parameters, saving their values into its internal memory and calculating average values. In order to provide average parameters such as precipitation per hour, etc, the weather station must remain powered.

However, this mode of use is not mandatory. For applications where it is not possible to add external power to the Plug & Sense! Smart Agriculture Xtreme, it is possible to turn the station on and off at specific periods of time and therefore receive punctual values of wind and rain. That is, it would not be possible to obtain every "average" calculated values nor "Precipitation total".

The energy consumption of the node will be determined by the measures needed for the application, so long term tests are recommended to see complete energy cycles.

You can find the complete sensor manual on the manufacturer's website.

4.16.19. Application examples

- Weather observation and forecast
- Evapotranspiration analysis
- Forest fires development forecast

4.16.20. Product test report

Together with this sensor we provide a product test report in which the manufacturer ensures that the sensor has passed the internal quality procedures.

4.17. Luminosity sensor (AMS TSL2561)

This is a light-to-digital converter that transforms light intensity into a digital signal output. This device combines one broadband photo-diode (visible plus infrared) and one infrared-responding photo-diode on a single CMOS integrated circuit capable of providing a near-photopic response over an effective 20-bit dynamic range (16-bit resolution). Two integrating ADCs convert the photo-diode currents to a digital output that represents the irradiance measured on each channel. This digital output in lux is derived using an empirical formula to approximate the human eye response.



Figure: Luminosity sensor probe (AMS TSL2561)

4.17.1. Specifications

- **Operating temperature:** -30 °C to +80 °C
- **Dynamic range:** 0.1 to 40000 Lux
- **Spectral range:** 300 – 1100 nm
- **Usage:** Indoors and outdoors

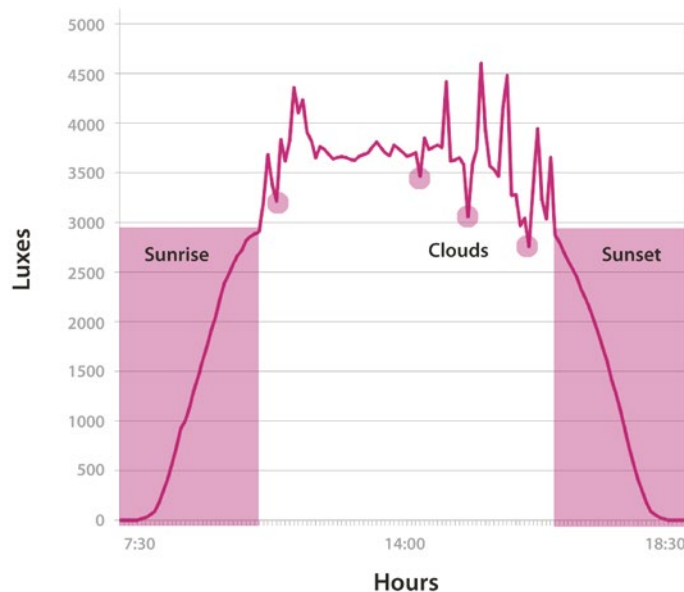

Figure: Luminosity sensor graphic

4.17.2. Measurement process

The luminosity sensor provides a digital signal using the I2C protocol.

Reading code:

```
{
// 1. Declare an object for the sensor
luxes mySensor(AGR_XTR_SOCKET_A);

// 2. Turn ON the sensor
mySensor.ON();

// 3. Read the sensor. Store parameters in local variables
uint32_t luminosity = mySensor.getLuminosity();

// 4. Turn off the sensor
mySensor.OFF();
}
```

You can find a complete example code for reading this sensor probe in the following link: <http://www.libelium.com/development/waspote/examples/ag-xtr-17-TSL2561-sensor-reading/>

4.17.3. Socket

Connect the Luminosity sensor probe to the Plug & Sense! Smart Agriculture Xtreme in any of the sockets shown in the image below.

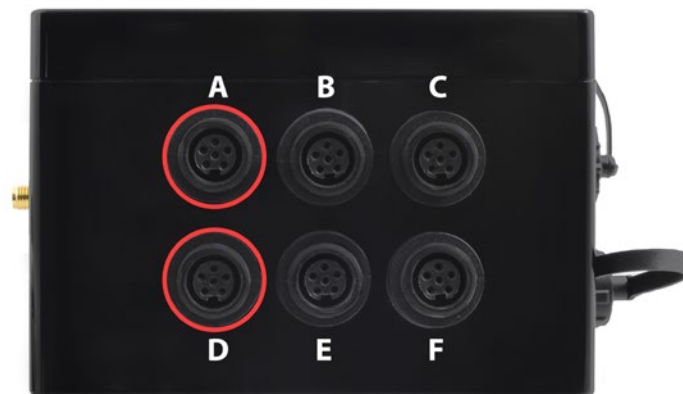

Figure: Available sockets for the Luminosity sensor probe

4.17.4. Application examples

- Light presence detection for artificial lightning usage

4.18. Ultrasound sensor probe (Maxbotix MB7040)

The Ultrasound sensor probe (MaxBotix MB7040) has high acoustic power output along with real-time auto calibration for changing conditions (voltage and acoustic or electrical noise) that ensure users receive the most reliable ranging data for every reading taken in air.



Figure: Ultrasound sensor (Maxbotix MB7040)

4.18.1. Specifications

- Operation frequency: 42 kHz
- Maximum detection distance: 765 cm
- Usage: Indoors and outdoors (IP-67)

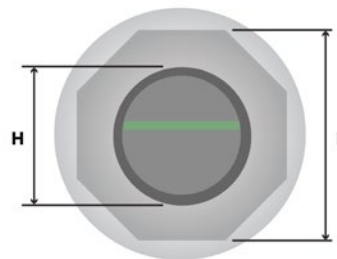
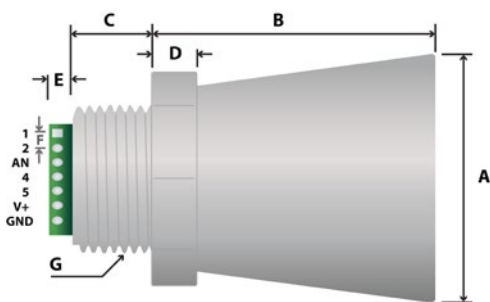

A	1.72" dia.	43.8 mm dia.
B	2.00"	50.7 mm
C	0.58"	14.4 mm
D	0.31"	7.9 mm
E	0.18"	4.6 mm
F	0.1"	2.54 mm
G	3/4" National Pipe Thread Straight	
H	1.032" dia.	26.2 dia.
I	1.37"	34.8 mm
weight: 1.76 oz. ; 50 grams		

Figure: Ultrasound sensor dimensions

4.18.2. Measurement process

The ultrasound sensor provides a digital signal using the I2C protocol.

Reading code:

```
{
  // 1. Declare an object for the sensor
  ultrasound mySensor(AGR_XTR_SOCKET_A);

  // 2. Turn ON the sensor
  mySensor.ON();

  // 3. Read the sensor. Store parameters in local variables
  uint16_t distance = mySensor.getDistance();

  // 4. Turn off the sensor
  mySensor.OFF();
}
```

You can find a complete example code for reading this sensor probe in the following link: <http://www.libelium.com/development/waspote/examples/ag-xtr-18-MB7040-sensor-reading>

4.18.3. Socket

Connect the ultrasound sensor to the Plug & Sense! Smart Agriculture Xtreme in any of the sockets shown in the image below.

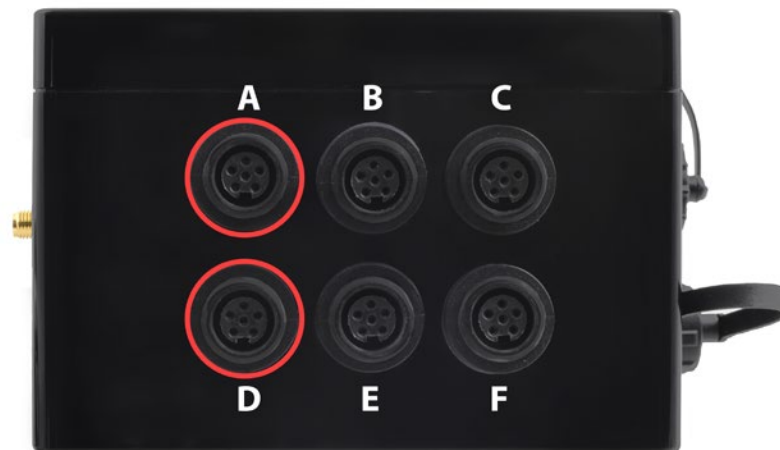

Figure: Available sockets for ultrasound sensor (Maxbotix MB7040)

4.18.4. Installation

The ultrasound sensor probe may be placed in different positions. The sensor can be focused directly to the point we want to measure.



Figure: ultrasound sensor (Maxbotix MB7040) installation

4.18.5. Application examples

- Tank level measurement
- Proximity zone detection
- People detection
- Distance measuring
- Security systems
- Motion detection
- Collision avoidance

5. Board configuration and programming

5.1. Hardware configuration

The Plug & Sense! Smart Agriculture Xtreme model does not require special handling of the hardware by the user, except for placing the sensors in their corresponding socket. In the previous sections each sensor connection has been described.

It is important to remark that Smart Agriculture Xtreme model is only available in the Waspote Plug & Sense! Line. It is not available for Waspote OEM line.

5.2. API

5.2.1. Before starting to program

When using the Plug & Sense! Smart Agriculture Xtreme model, remember that it is mandatory to include the `WaspSensorAgrXtr` library by introducing the next line at the beginning:

```
#include <WaspSensorAgrXtr.h>
```

The library manages the power supply and communication lines between Waspote and the sockets. Prior to read the sensor probes, the user must declare an object of the corresponding sensor class, specifying the socket where the sensor is placed. All sensor classes inherit from the class `WaspSensorAgrXtr`. The next table enumerates each sensor class.

Sensor probe	Sensor class
Non-contact surface temperature measurement sensor probe	<code>Apogee_SI411</code>
Leaf and flower bud temperature sensor probe	<code>Apogee_SF421</code>
Soil oxygen level sensor probe	<code>Apogee_S0411</code>
Shortwave radiation sensor probe	<code>Apogee_SP510</code>
Solar radiation sensor probe for Smart Agriculture Xtreme	<code>Apogee_SQ110</code>
Ultraviolet radiation sensor probe for Smart Agriculture Xtreme	<code>Apogee_SU100</code>
Temperature, humidity and pressure sensor probe	<code>bme</code>
Conductivity, water content and soil temperature GS3 sensor probe	<code>Decagon_GS3</code>
Conductivity, water content and soil temperature 5TE sensor probe	<code>Decagon_5TE</code>
Soil temperature and volumetric water content sensor probe	<code>Decagon_5TM</code>
Soil water potential sensor probe	<code>Decagon_MPS6</code>
Vapor pressure, humidity, temperature and pressure in soil and air sensor probe	<code>Decagon_VP4</code>
Leaf wetness Phytos 31 sensor probe	<code>leafWetness</code>
Dendrometer sensor probes for Smart Agriculture Xtreme	<code>dendrometer</code>
Weather station sensor probe	<code>weatherStation</code>
Luminosity sensor probe	<code>luxes</code>
Ultrasound sensor probe	<code>ultrasound</code>

Each sensor class manages the Smart Agriculture Xtreme sensor board according to its needs, so there is no need to turn on or off the whole board, as is often needed with other Libelium sensor boards. After declaring the object, the sensor can be turned on or off independently from each other. Incidentally, do not forget turning off the sensors to save battery when they are no longer needed.

The next snippet shows how to declare an object for the sensor 5TE and then how to turn on, read and turn off the sensor:

```
{
  // 1. Declare an object for the sensor
  Decagon_5TE mySensor(AGR_XTR_SOCKET_A);

  // 2. Turn ON the sensor
  mySensor.ON();

  // 3. Read the sensor. Values stored in class variables
  // Check complete code example for details
  mySensor.read();

  // 4. Turn off the sensor
  mySensor.OFF();
}
```

The `read()` function stores the sensor values in a public class. It does not return the values directly. The user can refer to the dedicated sensor example to see how the sensor values can be accessed. In the case of the 5TE sensor, values will be printed by USB with the following snippet.

```
{
  // 4. Print information
  USB.print(F("Dielectric Permittivity: "));
  USB.printFloat(mySensor.sensor5TE.dielectricPermittivity, 5);
  USB.println();

  USB.print(F("Electrical Conductivity: "));
  USB.printFloat(mySensor.sensor5TE.electricalConductivity, 5);
  USB.println(F(" dS/m"));

  USB.print(F("Soil temperature: "));
  USB.printFloat(mySensor.sensor5TE.temperature, 5);
  USB.println(F(" degrees Celsius"));
}
```

The Temperature, humidity and pressure, the Ultrasound and the Luminosity sensors have their own reading functions in contrast to the rest of the Smart Agriculture Xtreme sensors. This is due to these sensors can be used in other Plug & Sense! models and they share the same functions into the Waspote API. Refer to the dedicated sensor example for further details.

5.2.2. Sending sensor values with the Frame class

Owing to the large amount of parameters that can be read by the Plug & Sense! Smart Agriculture Xtreme model, a special frame type must be used with the Frame class in order to send the values correctly.

```
{
  // It is mandatory to specify the Smart Agriculture Xtreme type
  frame.setFrameType(AGR_XTR_FRAME);
}
```

You can find a complete example code for using the Frame class in the following link: <http://www.libelium.com/development/waspote/examples/ag-xtr-19-frame-class-utility>

Refer to the Data Frame Guide for more information: http://www.libelium.com/downloads/documentation/data_frame_guide.pdf

6. Consumption

6.1. Consumption table

The following table shows the power consumption of the Plug & Sense! Smart Agriculture Xtreme sensor probes. Remember that the sensor board can be completely disconnected by turning off all sensors, reducing the consumption to zero.

Added to that, some sensors are quite complex and they have various working modes, so the power consumption can vary. Values shown in the table are averages when the sensor is being read by Wasp mote.

Sensor probe	Current consumption
Non-contact surface temperature measurement	1.82 mA (quiescent), 2.68 mA (measuring)
Leaf and flower bud temperature	1.70 mA (quiescent), 2.60 mA (measuring)
Soil oxygen level	7.00 mA (quiescent), 8.20 mA (measuring)
Shortwave radiation	15 mA
Solar radiation for Smart Agriculture Xtreme	0 μ A
Ultraviolet radiation for Smart Agriculture Xtreme	0 μ A
Temperature, humidity and pressure	0.02 mA (quiescent), 0.19 mA (measuring)
Conductivity, water content and soil temperature GS3	0.05 mA (quiescent), 6.00 mA (measuring)
Conductivity, water content and soil temperature 5TE	0.05 mA (quiescent), 5.00 mA (measuring)
Soil temperature and volumetric water content	0.05 mA (quiescent), 5.00 mA (measuring)
Soil water potential	0.05 mA (quiescent), 5.00 mA (measuring)
Vapor pressure, humidity, temperature and pressure in soil and air	0.05 mA (quiescent), 5.00 mA (measuring)
Leaf wetness Phytos 31	3.85 mA
Dendrometer for Smart Agriculture Xtreme	160 μ A
Weather stations	Depends on the model (can be high)
Luminosity	0.02 mA (quiescent), 0.24 mA (measuring)

Figure: Power consumption for each sensor probe

7. API changelog

Keep track of the software changes on this link: www.libelium.com/development/waspmote/documentation/changelog/#SmartAgricultureXtreme

8. Documentation changelog

From v7.0 to v7.1:

- Added 13 new Gill weather stations
- Added advice about power supply for Gill weather stations
- Added formulas for VWC calculation
- Corrected Luminosity sensor example link
- Added info about calibration documents created by sensors manufacturers

9. Certifications

Libelium offers 2 types of IoT sensor platforms, Waspote OEM and Plug & Sense!:

- **Waspote OEM** is intended to be used for research purposes or as part of a major product so it needs final certification on the client side. More info at: www.libelium.com/products/waspote
- **Plug & Sense!** is the line ready to be used out-of-the-box. It includes market certifications. See below the specific list of regulations passed. More info at: www.libelium.com/products/plug-sense

Besides, Meshlium, our multiprotocol router for the IoT, is also certified with the certifications below. Get more info at:

www.libelium.com/products/meshlium

List of certifications for Plug & Sense! and Meshlium:

- CE (Europe)
- FCC (US)
- IC (Canada)
- ANATEL (Brazil)
- RCM (Australia)
- PTCRB (cellular certification for the US)
- AT&T (cellular certification for the US)



Figure: Certifications of the Plug & Sense! product line

You can find all the certification documents at:

www.libelium.com/certifications

10. Maintenance

- Although Wasmote is a highly resistant product, please handle with care in order to enjoy a longer useful life.
- Handle Wasmote Plug & Sense! with care, do not allow it to drop or move roughly.
- Avoid placing the devices in areas reaching high temperatures that could damage the electronic components.
- The antennas screw on gently to the connector, do not force upon installing or you could damage the connectors.
- Plug antennas or sensor probes only in their corresponding connectors.
- Do not use any type of paint on the device, it could affect the operation of connections and closing mechanisms.
- Do not store Wasmote Plug & Sense! in places exposed to dirt and dust in order to avoid damage to electronic components.
- Never open the casing, warranty will not cover products that have been opened.
- For cleaning, use a damp cloth, no aggressive chemical products.

11. Disposal and recycling

- When Wasmote Plug & Sense! reaches the end of its useful life it must be taken to a recycling point for electronic equipment.
- The equipment should be disposed of separately from solid urban waste, please dispose of correctly.
- Your distributor will advise you on the most appropriate and environmentally-friendly way of disposing of the product and its packing.

