

Wasmote Plug & Sense!

Technical Guide

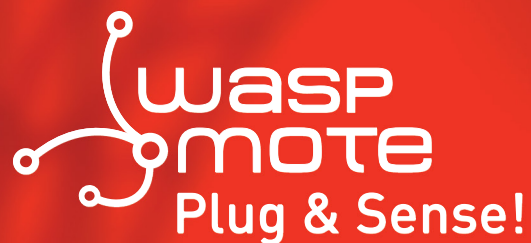
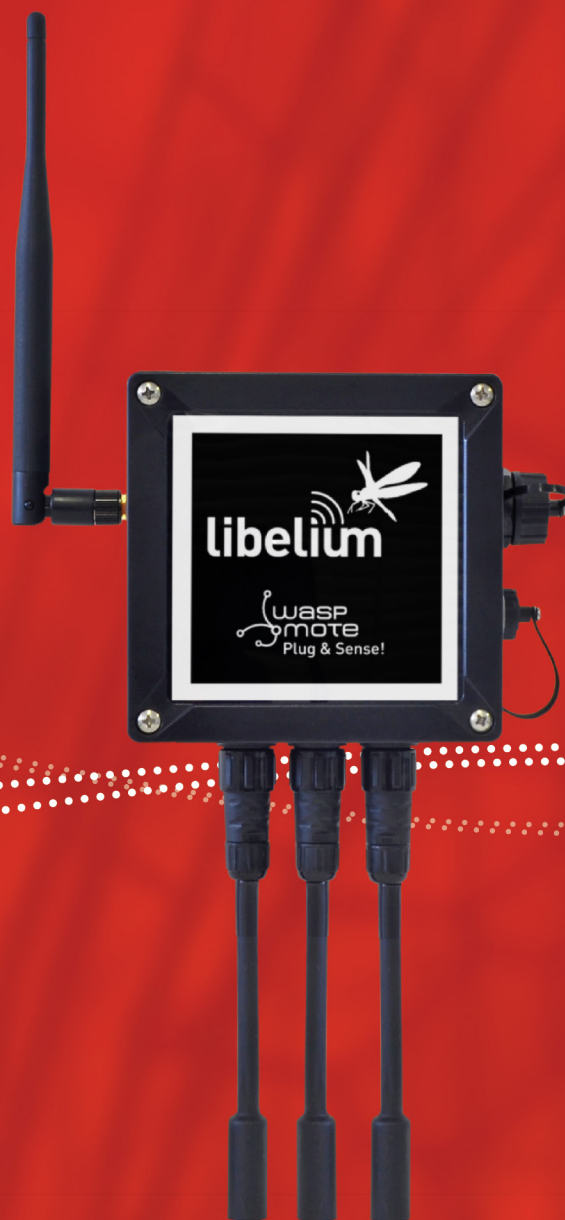

Document version: v7.5 - 02/2018
© Libelium Comunicaciones Distribuidas S.L.

INDEX

1. General and safety information.....	6
2. Important: Read before use.....	7
3. Introduction	8
4. Wasmote vs Wasmote Plug & Sense!.....	9
5. General view.....	10
5.1. Specifications.....	10
5.2. Parts included.....	13
5.3. Identification.....	14
6. Sensor probes.....	16
6.1. Sensor probes types.....	18
6.2. Extension cord.....	27
7. Internal sensors	29
7.1. Accelerometer	29
8. Radio modules.....	30
8.1. XBee-PRO 802.15.4	31
8.2. XBee 868LP	33
8.3. XBee-PRO 900HP.....	34
8.4. LoRaWAN modules	34
8.5. Sigfox modules.....	36
8.6. WiFi PRO module	37
8.7. 4G module	38
9. Industrial Protocols	40
10. GPS module.....	42
11. Internal storage	43
12. On/off button	44
12.1. External LED	45
13. Resetting Wasmote Plug & Sense! with an external magnet	46

14. USB port	48
14.1. Outdoors USB Cable.....	50
14.2. External SIM/USB socket.....	51
15. External solar panel.....	54
16. External Battery Module.....	56
16.1. Technical specifications.....	56
16.2. Operating modes.....	59
17. Vent plug / Pressure Compensator.....	61
18. Antenna.....	62
18.1. Antennas for the Plug & Sense! 4G model.....	63
18.2. Antennas for Plug & Sense! GPS-ready models	64
19. Sensor protection	66
19.1. Special probes.....	66
20. Battery	66
21. Models.....	67
21.1. Smart Environment PRO	68
21.2. Smart Security	71
21.3. Smart Water.....	73
21.4. Smart Water Ions	75
21.4.1. Single	76
21.4.2. Double	76
21.4.3. Pro.....	77
21.5. Smart Parking.....	78
21.6. Smart Agriculture.....	79
21.6.1. Normal.....	80
21.6.2. PRO	81
21.7. Ambient Control.....	82
21.8. Smart Cities PRO	84
21.9. Radiation Control.....	86
21.10. 4-20 mA Current Loop.....	87
22. Programming.....	88
22.1. Real time Clock - RTC.....	88
22.2. Interruptions	89
22.3. Watchdog.....	89
22.3.1. RTC Watchdog for resetting Waspnote	89

23. Programming Cloud Service	90
24. Uploading code.....	91
25. Over the air programming – OTA.....	97
25.1. Overview	97
25.2. OTA with 4G/WiFi modules via FTP	97
25.2.1. Setting the FTP server configuration	98
26. Encryption libraries	99
27. Interacting with Waspnote.....	100
27.1. Receiving XBee frames with Waspnote Gateway.....	100
27.1.1. Waspnote Gateway.....	100
27.1.2. Linux receiver	101
27.1.3. Windows receiver.....	105
27.1.4. Mac-OS receiver	107
28. Meshlium - The IoT Gateway	108
28.1. Meshlium Storage Options.....	108
28.2. Meshlium connection options.....	109
28.3. Meshlium Visualizer.....	110
28.4. Cloud Connectors	111
29. Installation	112
29.1. Parts.....	112
29.2. Street Light installation	115
29.2.1. External solar panel	115
29.3. Wall installation.....	118
29.3.1. External solar panel	118
30. Energy Consumption	120
30.1. Consumption tables	120
30.2. Energy system	120
30.2.1. Concepts.....	120
30.2.2. Sleep mode	122
30.2.3. Deep Sleep mode.....	123
30.3. Lifetime of the sensors.....	123
31. Recommendations.....	124
32. Documentation changelog	125

33. Certifications	126
33.1. General overview	126
33.2. CE (Europe)	126
33.2.1. Wasmote Plug & Sense! 802.15.4 EU.....	127
33.2.2. Wasmote Plug & Sense! 868.....	127
33.2.3. Wasmote Plug & Sense! WiFi	127
33.2.4. Wasmote Plug & Sense! 4G EU/BR.....	128
33.2.5. Wasmote Plug & Sense! Sigfox EU	128
33.2.6. Wasmote Plug & Sense! LoRaWAN EU	128
33.3. FCC (USA)	129
33.4. IC (Canada).....	130
33.5. ANATEL (Brazil).....	130
33.6. RCM (Australia).....	131
33.7. Use of equipment characteristics	132
34. Maintenance.....	133
35. Disposal and recycling.....	134
36. Resources.....	135

1. General and safety information

Important:

- All documents and any examples they contain are provided as-is and are subject to change without notice. Except to the extent prohibited by law, Libelium makes no express or implied representation or warranty of any kind with regard to the documents, and specifically disclaims the implied warranties and conditions of merchantability and fitness for a particular purpose.
- The information on Libelium's websites has been included in good faith for general informational purposes only. It should not be relied upon for any specific purpose and no representation or warranty is given as to its accuracy or completeness.

- Read carefully Limited Warranty and Terms and Conditions of Use before using "Wasmote Plug & Sense!".
- Do not open casing and do not damage black warranty stickers. If you do so, you will lose warranty.
- Do not remove any of the connectors.
- Do not allow contact between metallic objects and electronic parts to avoid injury and burns.
- Never immerse equipment in any liquid.
- Keep equipment within temperature range indicated in recommendation section.
- Do not connect or power equipment using cables that have been damaged.
- Place equipment in an area to which only maintenance personnel can have access (in a restricted access zone).
- In any case keep children away from the equipment.
- If there is a power failure, immediately disconnect from the mains.
- If using a battery whether or not in combination with a solar panel as a power source follow the voltage and current specifications indicated in the section "External solar panel connector".
- If a software failure occurs, contact Libelium technical support before doing any action by yourself.
- Do not place equipment on trees or plants as they could be damaged by its weight.
- Be particularly careful if you are connected through a software interface for handling the machine; if settings of that interface are incorrectly altered, it could become inaccessible.
- If you need to clean the node, wipe it with a dry towel.
- If Wasmote Plug & Sense! needs to be returned please send it completely dry and free from contaminants.
- Wasmote Plug & Sense! is not designed to be placed in hard environmental conditions, under dangerous chemical elements, explosive atmospheres with flammable gases, high voltage installations or special installations. Please contact Libelium technical support to ensure your application is compatible with Wasmote Plug & Sense!

2. Important: Read before use

The following list shows just some of the actions that produce the most common failures and warranty-voiding. Complete documentation about usage can be found at <http://www.libelium.com/development>. Failure to comply with the recommendations of use will entail the warranty cancellation.

Software:

- Upload code only using Waspote IDE. If a different IDE is used, Waspote can be damaged and can become unresponsive. This use is not covered under warranty.
- Do not unplug any connector while uploading code. Waspote can become unresponsive. This use is not covered under warranty.
- Do not connect or disconnect any connector while Waspote is on. Waspote can become unstable or unresponsive, and internal parts can be damaged. This fact is not covered under warranty.

Hardware:

- Do not handle black stickers seals on both sides of the enclosure (Warranty stickers). Their integrity is the proof that Waspote Plug & Sense! has not been opened. If they have been handled, damaged or broken, the warranty is void.
- Do not open Waspote Plug & Sense! in any case. This will automatically make the warranty void.
- Do not handle the four metallic screws of Waspote Plug & Sense!. They ensure waterproof seal.
- Do not submerge Waspote Plug & Sense! in liquids.
- Do not place nodes on places or equipment where it could be exposed to shocks and/or big vibrations.
- Do not expose Waspote Plug & Sense! to temperatures below -20 °C or above 60 °C.
- Do not power Waspote with other power sources than the original provided by Libelium. Voltage and current maximum ratings can be exceeded, stopping Waspote working and voiding warranty.
- Do not try to extract, screw, break or move Waspote Plug & Sense! connectors far from necessary usage, waterproof sealing can be damaged and warranty will be voided.
- For more information: <http://www.libelium.com>
- Do not connect any sensor on the solar panel connector and also do not connect the solar panel to any of sensor connectors. Waspote can be damaged and warranty void.
- Do not connect any sensor not provided by Libelium.
- Do not place Waspote Plug & Sense! where water can reach internal parts of sensors.
- Do not get the magnet close to a metal object. The magnet is really powerful and will get stuck.
- Do not place the magnet close to electronic devices, like PCs, batteries, etc, they could be damaged, or information could be deleted.

3. Introduction

This guide explains the features related to our product line Plug & Sense! v15, released on October 2016.

If you are using previous versions of our products, please use the corresponding guides, available on our [Development website](#).

You can get more information about the generation change on the document "[New generation of Libelium product lines](#)".

4. Wasp mote vs Wasp mote Plug & Sense!

Wasp mote is the original line in which developers have a total control over the hardware device. You can physically access to the board and connect new sensors or even embed it in your own products as an electronic sensor device.

The Wasp mote Plug & Sense! line allows developers to forget about electronics and focus on services and applications. You can deploy wireless sensor networks in an easy and scalable way ensuring minimum maintenance costs. The platform consists of a robust waterproof enclosure with specific external sockets to connect the sensors, the solar panel, the antenna and even the USB cable in order to reprogram the node. It has been specially designed to be scalable, easy to deploy and maintain.



Figure: Wasp mote



Figure: Wasp mote Plug & Sense!

5. General view

This section shows main parts of Waspote Plug & Sense! and a brief description of each one. In later sections all parts will be described deeply.

5.1. Specifications

- **Material:** polycarbonate
- **Sealing:** polyurethane
- **Cover screws:** stainless steel
- **Ingress protection:** IP65
- **Impact resistance:** IK08
- **Rated insulation voltage AC:** 690 V
- **Rated insulation voltage DC:** 1000 V
- **Heavy metals-free:** Yes
- **Weatherproof:** true - nach UL 746 C
- **Ambient temperature (min.):** -30 °C*
- **Ambient temperature (max.):** 70 °C*
- **Approximated weight:** 800 g

* Temporary extreme temperatures are supported. Regular recommended usage: -20, +60 °C.

In the pictures included below it is shown a general view of Waspote Plug & Sense! main parts. Some elements are dedicated to node control, others are designated to sensor connection and other parts are just identification elements. All of them will be described along this guide.

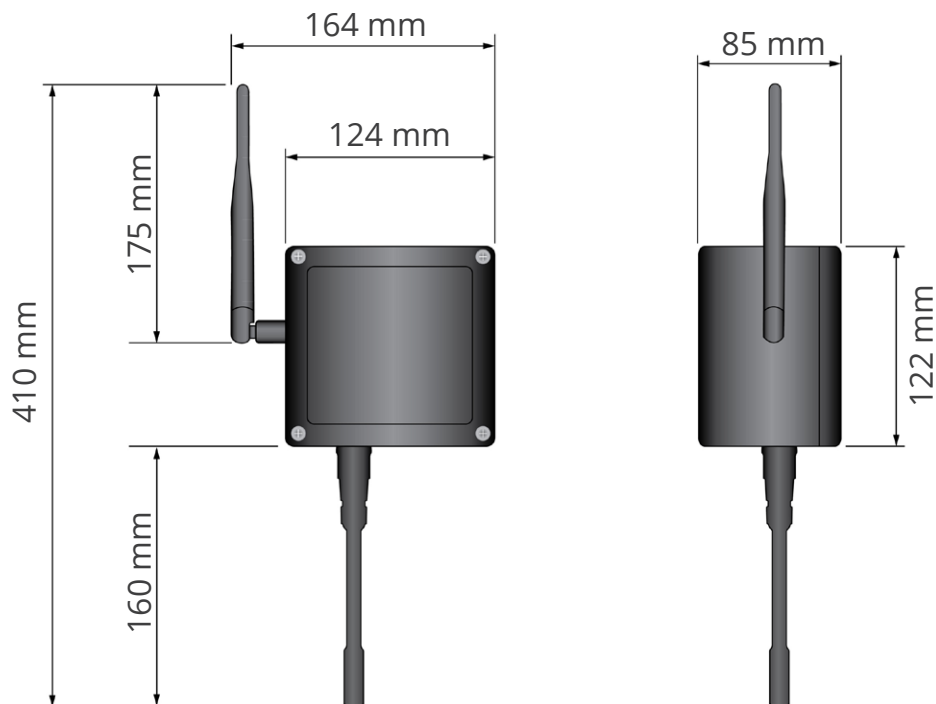

Figure: Main view of Waspote Plug & Sense!

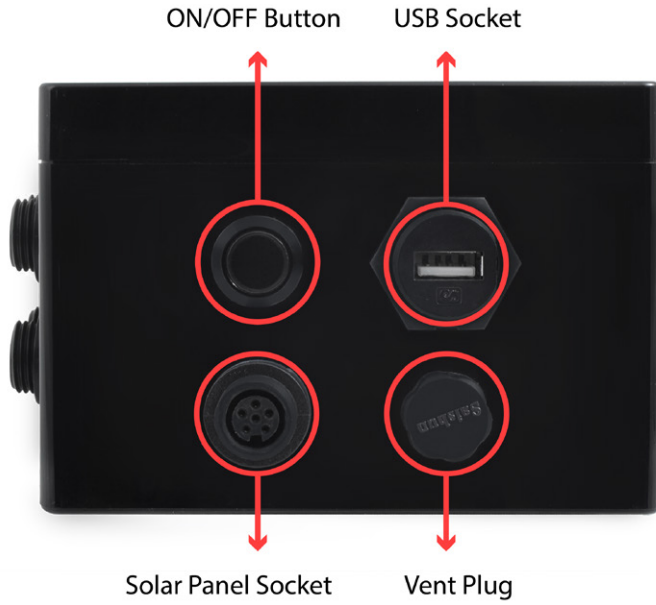

Figure: Control side of the enclosure

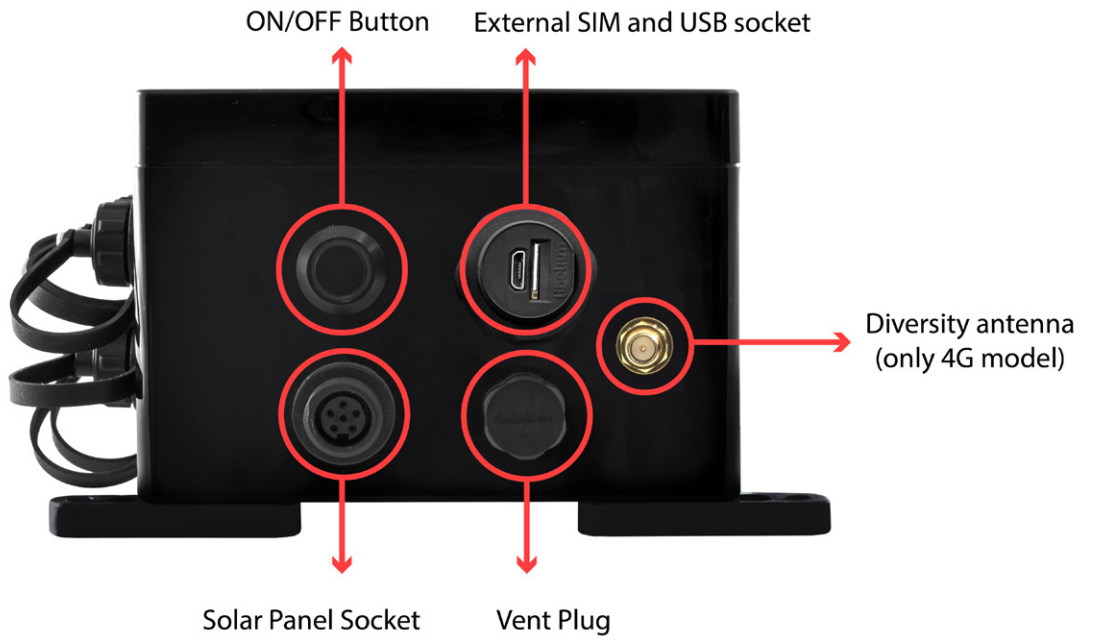

Figure: Control side of the enclosure for 4G model



Figure: Sensor side of the enclosure

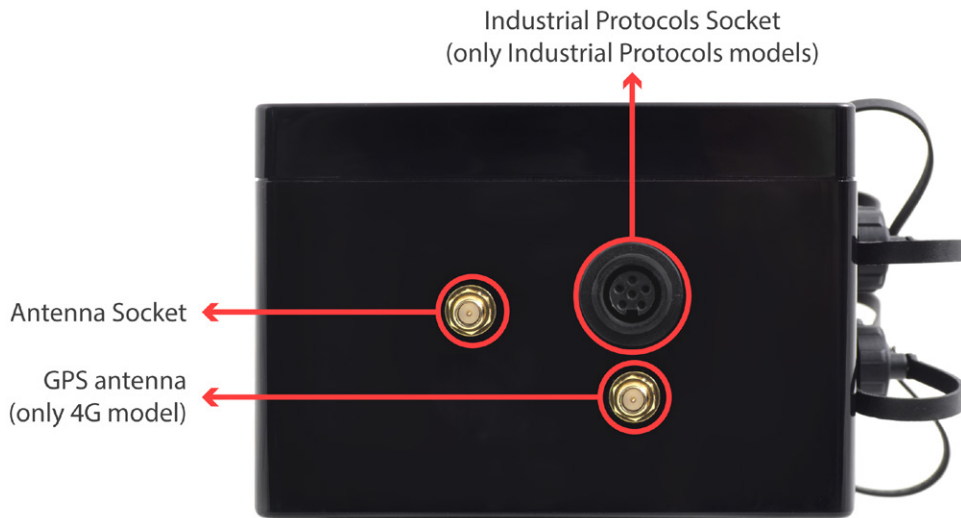

Figure: Antenna side of the enclosure



Figure: Front view of the enclosure



Figure: Back view of the enclosure



Figure: Warranty stickers of the enclosure

Important note: Do not handle black stickers seals of the enclosure (Warranty stickers). Their integrity is the proof that Waspote Plug & Sense! has not been opened. If they have been handled, damaged or broken, the warranty is automatically void.

5.2. Parts included

Next picture shows Waspote Plug & Sense! and all of its elements. Some of them are optional accessories that may not be included.



Figure: Waspote Plug & Sense! accessories: 1 enclosure, 2 sensor probes, 3 external solar panel, 4 USB cable, 5 antenna, 6 cable ties, 7 mounting feet (screwed to the enclosure), 8 extension cord, 9 solar panel cable, 10 wall plugs & screws

5.3. Identification

Each Wasp mote model is identified by stickers. Next figure shows front sticker.

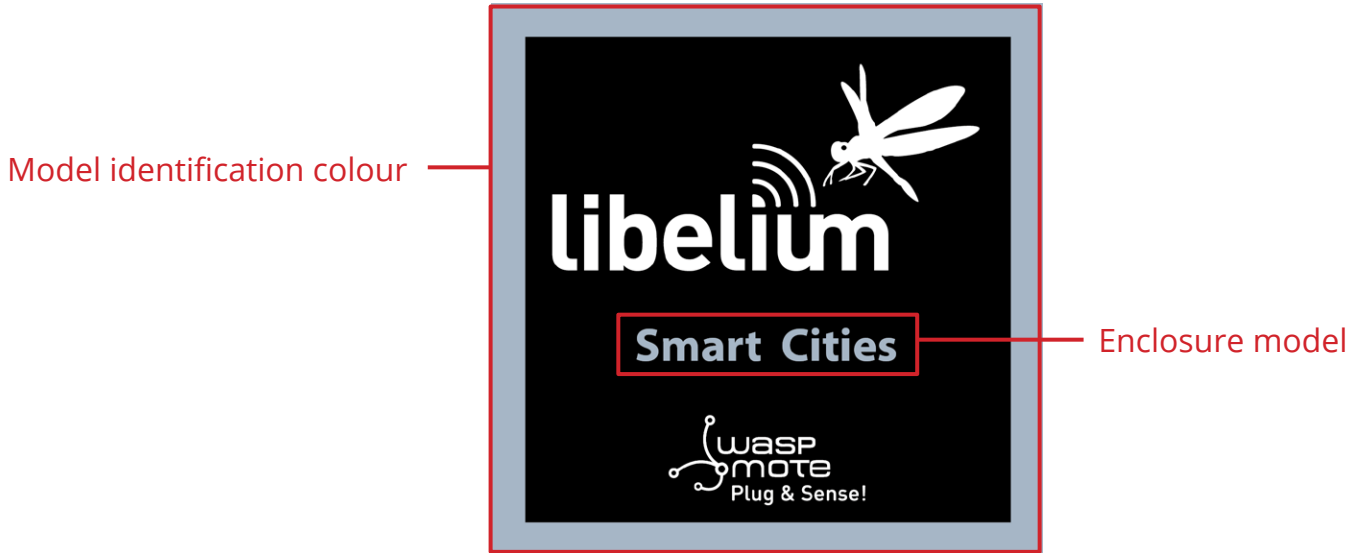



Figure: Front sticker of the enclosure

There are many configurations of Wasp mote Plug & Sense! line, all of them identified by one unique sticker. Next image shows all possibilities.



Figure: Different front stickers

Moreover, Wasmote Plug & Sense! includes a back sticker where it is shown identification numbers, radio MAC addresses, etc. It is highly recommended to annotate this information and save it for future maintenance. Next figure shows it in detail.

Brand name: Libelium	Country of origin: Spain
Plug & Sense! model	Model: Wasmote Plug & Sense! WiFi
Device serial number	Serial ID: xxxxxxxxxx
Battery type	Battery: 6600 mA·h rechargeable
Radio type	Radio: WiFi
Sensor board and extra info	Info: Smart Environment
	FCC ID: XKM-WPS-WIFI-V1
	IC: 8472A-WPSWIFIV1
	<small>This device complies with Part 15 of the FCC Rules. Operation is subject to the following two conditions: (1) this device may not cause harmful interference, and (2) this device must accept any interference received, including interference that may cause undesired operation.</small>
Certifications info	<small>Este equipamento opera em caráter secundário, isto é, não tem direito a proteção contra interferência prejudicial, mesmo de estações do mesmo tipo, e não pode causar interferência a sistemas operando em caráter primário.</small>
	

Figure: Back sticker

Sensor probes are identified too by a sticker showing the measured parameter and the sensor manufacturer reference.



Figure: Sensor probe identification sticker

6. Sensor probes

All sensing capabilities of Wasp mote Plug & Sense! are provided by sensor probes. Each sensor probe contains one sensor, some necessary protections against outdoor environmental conditions and a waterproof male connector.

The standard length of a sensor probe is about 150 mm, including waterproof connector, but it could vary due to some sensors need special dimensions. Weight of a standard probe rounds 20 g, but there are some special cases which this weight can rise.

Sensor probes are designed to be used in vertical position (with sensor looking to the ground). In this position, the protection cap of each sensor probe is effective against bad weather conditions.

Each model has six dedicated sockets to connect sensor probes. They are located in the sensor side, as shown below. Each socket has a protecting cap. When one of the six sensor connectors is not used, be sure the cap is screwed to protect the connector.



Figure: Enclosure sensor side with protection caps

Each sensor socket is identified by a letter from A to F (see picture below). The user should understand that each sensor probe should go in a dedicated socket, due to each sensor has different power requirements (current and voltage levels), dedicated circuitry, etc. So please see corresponding section about where to connect each probe.

Always be sure you connected probes in the right socket, otherwise they can be damaged.

Never connect a sensor not provided by Libelium to any of the sensor connectors. The electronics system inside can be damaged and the warranty will be automatically void.



Figure: Enclosure sensor side without protection caps

It should be taken into account that any sensor probe connector has only one matching position with a sensor probe. The user should align the sensor probe connector looking at the little notch of the connector (see image below). Notice that the sensor connector is male type and the enclosure sensor connector is female type.



Figure: Detail of sensor waterproof connector

Besides that, there is a locking nut which should be screwed till the connector is completely fixed to the enclosure.



Figure: Connecting a sensor probe to the enclosure

Please use only sensors officially provided by Libelium. Any other sensor can damage Wasp mote Plug & Sense! and void the warranty.

6.1. Sensor probes types

Libelium provides many different sensor probes depending on what is going to be measured. This section describes main features of each type. If further information is required, please refer for the corresponding sensor board guide available on [Libelium website](#).

Standard type

This sensor probe is the most common. The sensor is placed inside a plastic cylinder acting as a protection against rain and water, but allowing sensor interact with environment to measure necessary parameters. Besides, the sensor is kept always straight and the size and shape of the probes are standardized as maximum as possible.



Figure: Standard sensor probe

Sensor probes of this type are all the gas sensors of the Smart Environment and the Smart Environment PRO models (except for the temperature, humidity and pressure sensor and the particle matter sensor).

White protection probe

This probe is designed to avoid sunlight effects and prevent from water and rain, but allowing humidity measurement.

Only the temperature, humidity and pressure sensor include this special protection.



Figure: Temperature, humidity and pressure probe

Luminosity - LDR probe

This probe is designed to allow sunlight go through a transparent protection.



Figure: Luminosity probe

Liquid Presence probe (point)

This probe is designed to allow placing the sensor near its application.



Figure: Liquid Presence probe (point)

Liquid level probe

This probe is designed to measure liquid levels.



Figure: Liquid level probe

Liquid flow probe

This probe is designed to measure liquid flow through a pipe.



Figure: Liquid flow probe

Hall effect probe

This probe is designed to control the opening of doors, windows, etc.



Figure: Hall effect probe

Solar radiation probe

This probe is designed to measure solar radiation.



Figure: Solar radiation probe

Soil temperature probe

This probe is designed to be buried into the ground to measure its temperature.



Figure: Soil temperature probe

Soil moisture probe

This probe is designed to be buried into the ground to measure its moisture.



Figure: Soil moisture probe

Dendrometer probe

This probe is designed to measure trunk, stem and fruit diameter of vegetables.



Figure: Dendrometer probe

Leaf wetness probe

This probe is designed to measure wetness on vegetable leaves.



Figure: Leaf wetness probe

Weather Station WS-3000 probe

This probe is designed to measure wind direction, wind speed and rain.



Figure: Weather Station WS-3000 probe

Liquid Presence probe (line)

This probe is designed to allow placing the sensor near its application.



Figure: Liquid Presence probe (line)

Directionable type

This type of probe is only for some sensors. The sensor is placed inside a plastic modular hose that allows us to point them where we want to measure with it.



Figure: Configurations of directionable sensor probes

Sensor probes of this type are:

- **Presence - PIR directionable probe**

This probe is designed to allow infrared light through a lens, necessary for presence applications.



Figure: Presence (PIR) directionable probe

- **Ultrasound sensor directionable probe**

This probe is designed to measure distances using ultrasonic waves.



Figure: Ultrasound directionable probe

- **Luminosity (Luxes accuracy) directionable probe**

This probe is designed to measure luxes indoors and outdoors.



Figure: Luminosity (luxes accuracy) directionable probe

- **Terminal box probe**

This probe allow access to the 4-20 mA current loop board signals, to the relay contacts on Smart Security models (max 30 VDC, 1 A) and also to allow access to the optional Industrial Protocols feature (RS-232, RS-485, Modbus and CAN Bus) in the Waspnote Plug & Sense! encapsulated line. A waterproof terminal block junction box is provided as a probe, making the connections on industrial environments or outdoor applications easier.



Figure: Terminal box probe

- **DB9 probe**

The DB9 connector is commonly used in many applications with data transmission on industrial ambients. Libelium provides this probe with a standard DB9 female connector and a length of 1.5 meters.



Figure: DB9 probe

6.2. Extension cord

This element is used when one sensor needs to be placed far from the node. Two lengths are available: 1.5 and 3 m. Next picture shows an extension cord.



Figure: Extension cord accessory

The extension cord has a female and a male connector. The first one (female) should be connected to the sensor probe. Next picture shows that.



Figure: Connecting a probe with an extension cord

Moreover, the male connector should be connected to the enclosure as shown below.



Figure: Connecting an extension cord to the enclosure

7. Internal sensors

7.1. Accelerometer

Waspote has a built-in acceleration sensor which informs the mote of acceleration variations experienced on each one of the 3 axes (X, Y, Z). The integration of this sensor allows the measurement of acceleration on the 3 axes (X, Y, Z), establishing 2 kinds of events: Free Fall and Direction Detection Change.



Figure: Axis direction in Waspote Plug & Sense!

Complete information can be found in the [Accelerometer Programming Guide](#).

8. Radio modules

WaspMote Plug & Sense! may integrate many radio modules for wireless communications.

Radio	Protocol	Frequency bands	Transmission power	Sensitivity	Range*	Certification
XBee-PRO 802.15.4 EU	802.15.4	2.4 GHz	10 dBm	-100 dBm	750 m	CE
XBee-PRO 802.15.4	802.15.4	2.4 GHz	18 dBm	-100 dBm	1600 m	FCC, IC, ANATEL, RCM
XBee 868LP	RF	868 MHz	14 dBm	-106 dBm	8.4 km	CE
XBee 900HP US	RF	900 MHz	24 dBm	-110 dBm	15.5 km	FCC, IC
XBee 900HP BR	RF	900 MHz	24 dBm	-110 dBm	15.5 km	ANATEL
XBee 900HP AU	RF	900 MHz	24 dBm	-110 dBm	15.5 km	RCM
WiFi	WiFi (HTTP(S), FTP, TCP, UDP)	2.4 GHz	17 dBm	-94 dBm	500 m	CE, FCC, IC, ANATEL, RCM
4G EU/BR	4G/3G/2G (HTTP, FTP, TCP, UDP) GPS	800, 850, 900, 1800, 2100, 2600 MHz	4G: class 3 (0.2 W, 23 dBm)	4G: -102 dBm	- km - Typical base station range	CE, ANATEL
4G US	4G/3G/2G (HTTP, FTP, TCP, UDP) GPS	700, 850, 1700, 1900 MHz	4G: class 3 (0.2 W, 23 dBm)	4G: -103 dBm	- km - Typical base station range	FCC, IC, PTCRB, AT&T
4G AU	4G (HTTP, FTP, TCP, UDP)	700, 1800, 2600 MHz	4G: class 3 (0.2 W, 23 dBm)	4G: -102 dBm	- km - Typical base station range	RCM
Sigfox EU	Sigfox	868 MHz	16 dBm	-126 dBm	- km - Typical base station range	CE
Sigfox US	Sigfox	900 MHz	24 dBm	-127 dBm	- km - Typical base station range	FCC, IC
LoRaWAN EU	LoRaWAN	868 MHz	14 dBm	-136 dBm	> 15 km	CE
LoRaWAN US	LoRaWAN	900 MHz	18.5 dBm	-136 dBm	> 15 km	FCC, IC

* Line of sight, Fresnel zone clearance and 5dBi dipole antenna.

These modules have been chosen for their high receiving sensitivity and transmission power, as well as for being 802.15.4 compliant (XBee-802.15.4 model) and ZigBee-Pro v2007 compliant (XBee-ZB model).

8.1. XBee-PRO 802.15.4

Radio version	Frequency	Transmission power	Sensitivity	Range*
XBee-PRO 802.15.4 EU	2.4 GHz	10 dBm	-100 dBm	750 m
XBee-PRO 802.15.4		18 dBm		1600 m

* To determine your range, perform a range test under your operating conditions

The frequency used is the free band of 2.4 GHz, using 12 channels with a bandwidth of 5 MHz per channel.

2.4GHz Band

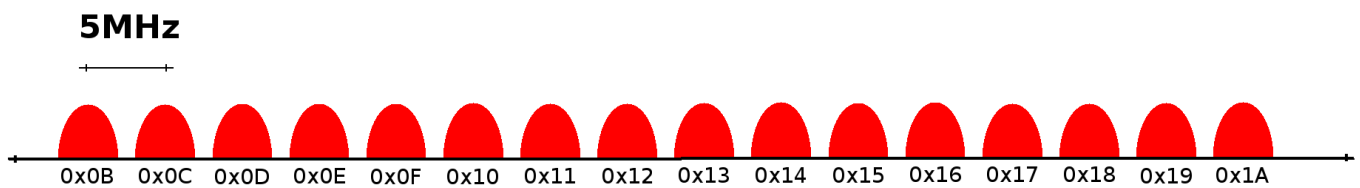

Figure: Frequency channels in the 2.4 GHz band

Channel Number	Frequency
0x0C – Channel 12	2.405 – 2.410 GHz
0x0D – Channel 13	2.410 – 2.415 GHz
0x0E – Channel 14	2.415 – 2.420 GHz
0x0F – Channel 15	2.420 – 2.425 GHz
0x10 – Channel 16	2.425 – 2.430 GHz
0x11 – Channel 17	2.430 – 2.435 GHz
0x12 – Channel 18	2.435 – 2.440 GHz
0x13 – Channel 19	2.440 – 2.445 GHz
0x14 – Channel 20	2.445 – 2.450 GHz
0x15 – Channel 21	2.450 – 2.455 GHz
0x16 – Channel 22	2.455 – 2.460 GHz
0x17 – Channel 23	2.460 – 2.465 GHz

Figure: Channels used by the XBee modules in 2.4GHz

The XBee-PRO 802.15.4 modules comply with the standard **IEEE 802.15.4** which defines the physical level and the link level (MAC layer). The XBee modules add certain functionalities to those contributed by the standard, such as:

- **Node discovery:** certain information has been added to the packet headers so that they can discover other nodes on the same network. It allows a node discovery message to be sent, so that the rest of the network nodes respond indicating their data (Node Identifier, @MAC, @16 bits, RSSI).
- **Duplicated packet detection:** This functionality is not set out in the standard and is added by the XBee modules.

The classic topology of this type of network is a star topology, as the nodes establish point to point connections with brother nodes through the use of parameters such as the MAC or network address.

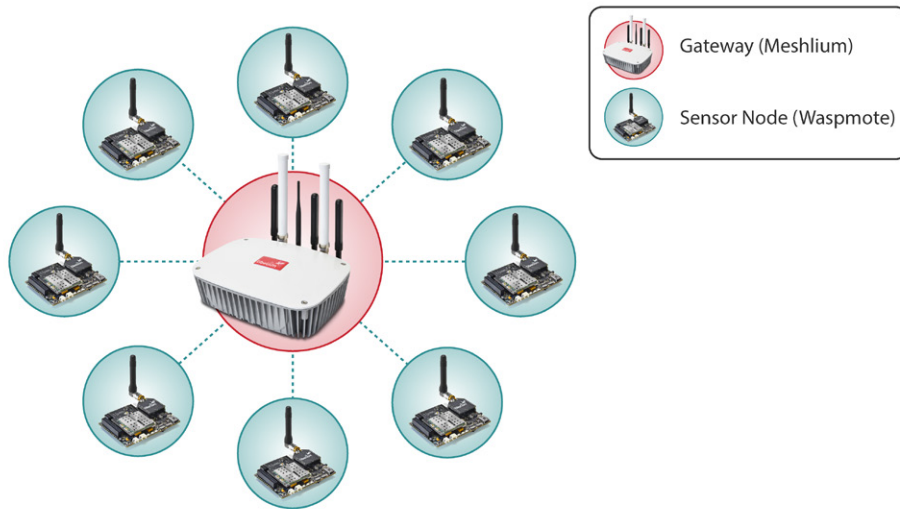

Figure: Star topology

Regarding the transmission power, it can be adjusted to several values depending on the radio version:

Parameter	XBee-PRO 802.15.4	XBee-PRO 802.15.4 EU
0	10 dBm	-3 dBm
1	12 dBm	-3 dBm
2	14 dBm	2 dBm
3	16 dBm	8 dBm
4	18 dBm	10 dBm

Figure: Transmission power values

Related API libraries: **WaspXBeeCore.h**, **WaspXBeeCore.cpp**, **WaspXBee802.h**, **WaspXBee802.cpp**

All information about their programming and operation can be found in the [802.15.4 Networking Guide](#).

All the documentation is located in the [Development section](#) in the Libelium website.

8.2. XBee 868LP

Radio version	Frequency	Transmission power	Sensitivity	Range*
XBee 868LP	863 - 870 MHz	14 dBm	-106 dBm	8.4 km

* To determine your range, perform a range test under your operating conditions

Note: The XBee 868 MHz module is provided with 4.5dBi antenna, which enables maximum range.

The frequency used is the 868 MHz band, using 30 software selectable channels. Channels are spaced 100 kHz apart. The transmission rate is 10 kbps.

The classic **topology** for this type of network is a star topology, as the nodes can establish point-to-point connections with brother nodes through the use of the MAC address.

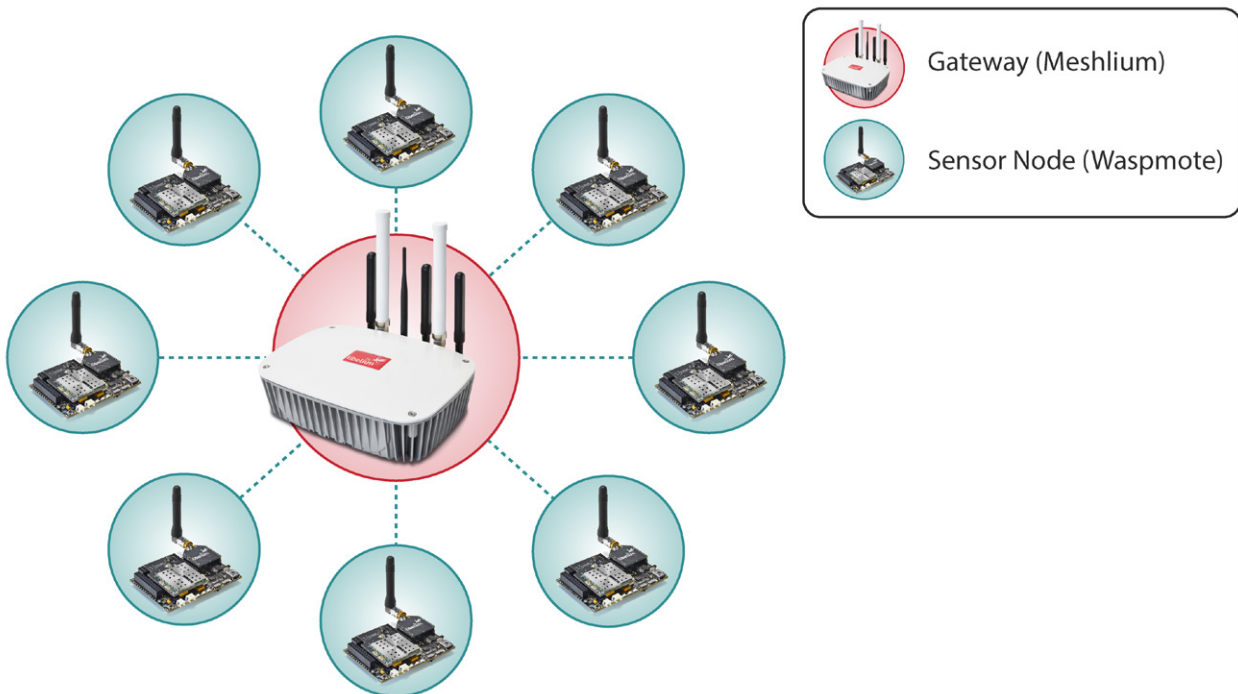

Figure: Star topology

Regarding the transmission power, it can be adjusted to several values:

Parameter	XBee 868LP
0	3 dBm
1	7 dBm
2	10 dBm
3	12 dBm
4	14 dBm

Figure: Transmission power values

Related API libraries: **WaspXBeeCore.h**, **WaspXBeeCore.cpp**, **WaspXBee868LP.h**, **WaspXBee868LP.cpp**

All information about their programming and operation can be found in the [868 Networking Guide](#).

All the documentation is located in the [Development section](#) in the Libelium website.

8.3. XBee-PRO 900HP

Radio version	Frequency	Transmission power	Sensitivity	Range*
XBee-PRO 900HP US	902 - 928 MHz	24 dBm	-110 dBm	15.5 km
XBee-PRO 900HP BR	902 - 906.8 MHz 915.6 - 928 MHz			
XBee-PRO 900HP AU	915.6 - 928 MHz			

* To determine your range, perform a range test under your operating conditions

The frequency used is the 900 MHz band, using 64 software selectable channels. Channels are spaced 400 kHz apart. The transmission rate is 10 kbps. There are different versions of the XBee 900HP: USA & Canada, Brazil and Australia.

The different versions differ mainly in the available channels, which are hard-coded in the XBee. Be aware that it is not possible to change from one version to other with just a firmware change. **According to the country where the user is located, a different version must be chosen.**

The classic topology for this type of network is a star topology, as the nodes can establish point-to-point connections with brother nodes through the use of parameters such as the MAC address or that of the network.

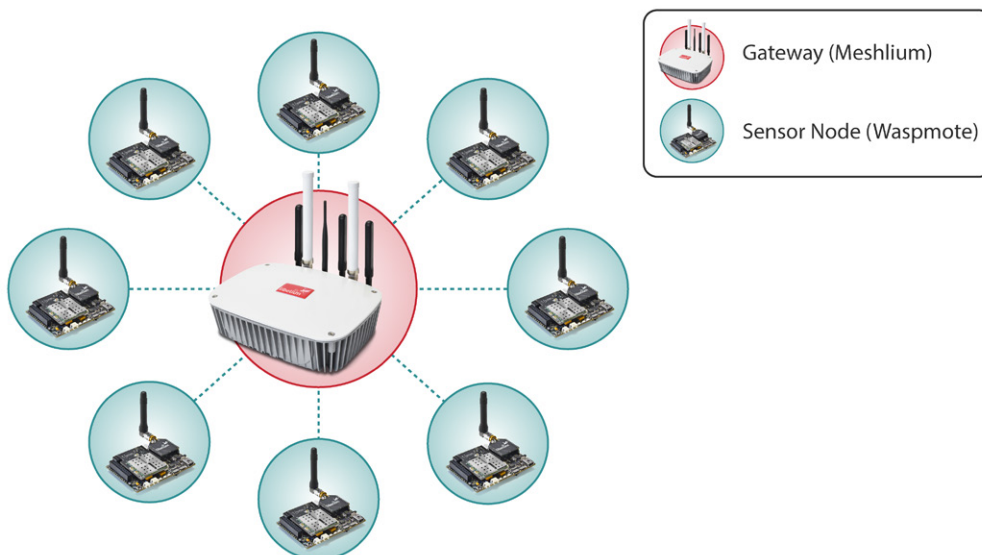

Figure: Star topology

API libraries: **WaspXBeeCore.h**, **WaspXBeeCore.cpp**, **WaspXBee900HP.h**, **WaspXBee900HP.cpp**

All information about their programming and operation can be found in the [900 Networking Guide](#).

All the documentation is located in the [Development section](#) in the Libelium website.

8.4. LoRaWAN modules

LoRaWAN is a Low Power Wide Area Network (LPWAN) specification intended for wireless battery-operated devices in regional, national or global network. LoRaWAN target key requirements of Internet of things such as secure bi-directional communication, mobility and localization services. This standard will provide seamless interoperability among smart Things without the need of complex local installations and gives back the freedom to the user, developer, businesses enabling the role out of Internet of Things.

LoRaWAN network architecture is typically laid out in a star-of-stars topology in which gateways is a transparent bridge relaying messages between end-devices and a central network server in the back-end. Gateways are connected to the network server via standard IP connections while end-devices use single-hop wireless communication to one or many gateways.

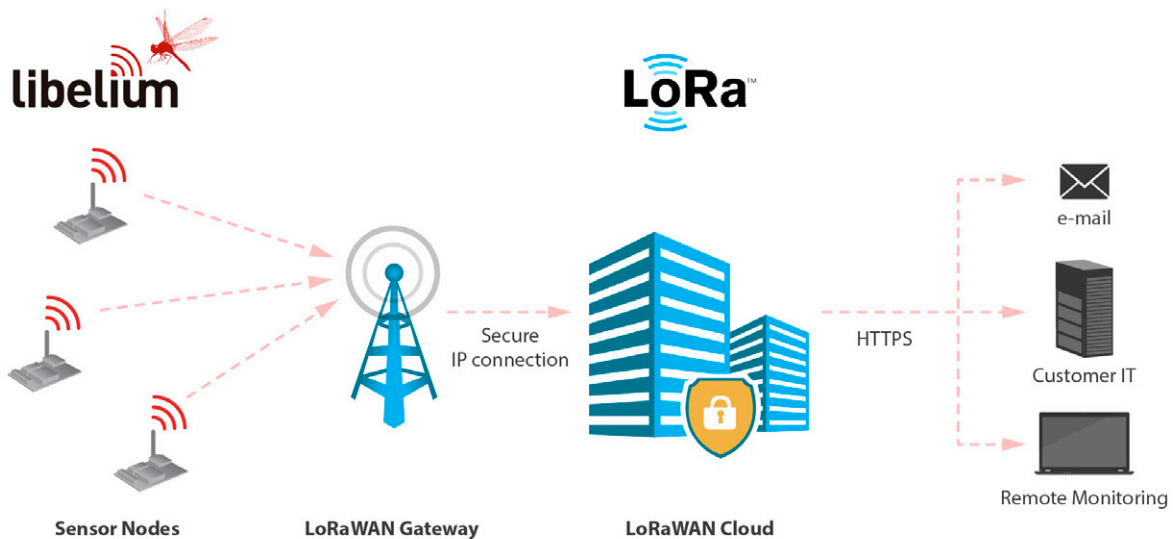

Figure: LoRaWAN network

Communication between end-devices and gateways is spread out on different frequency channels and data rates. The selection of the data rate is a trade-off between communication range and message duration. Due to the spread spectrum technology, communications with different data rates do not interfere with each other and create a set of “virtual” channels increasing the capacity of the gateway. To maximize both battery life of the end-devices and overall network capacity, the LoRaWAN network server is managing the data rate and RF output for each end-device individually by means of an adaptive data rate (ADR) scheme.

National wide networks targeting Internet of Things such as critical infrastructure, confidential personal data or critical functions for the society has a special need for secure communication. This has been solved by several layer of encryption.

Protocol: LoRaWAN 1.0, Class A

LoRaWAN-ready

Frequency:

- LoRaWAN 868/433 modules: 868 MHz and 433 MHz ISM bands
- LoRaWAN 900 module: 900-930 MHz ISM band

TX power:

- LoRaWAN 868/433 modules: up to 14 dBm
- LoRaWAN 900 module: up to 18.5 dBm

Sensitivity: down to -136 dBm

Range: >15 km at suburban and >5 km at urban area. Typically, each base station covers some km. Check the LoRaWAN Network in your area.

Chipset consumption:

- LoRaWAN 868/433 modules: 38.9 mA
- LoRaWAN 900 module: 124.4 mA

Radio data rate:

- LoRaWAN 868/433 modules: from 250 to 5470 bps
- LoRaWAN 900 module: from 250 to 12500 bps

Receiver: purchase your own base station or use networks from LoRaWAN operators

Related API libraries: **WaspLoRaWAN.h**, **WaspLoRaWAN.cpp**

All the information about their programming and operation can be found in the [LoRaWAN Networking Guide](#) available at Development section of Libelium website.

8.5. Sigfox modules

Sigfox is a private company that aims to build a worldwide network especially designed for IoT devices. The network is cellular, with thousands of base stations deployed in each country. Sigfox technology offers very long ranges for low-power, battery-constrained nodes. Sigfox is great for very simple and autonomous devices which need to send small amounts of data to this ubiquitous network, taking advantage on the Sigfox infrastructure.

So Sigfox is similar to cellular (GSM-GPRS-3G-4G) but is more energy-efficient, and the annual fees are lower.

Sigfox uses a UNB (Ultra Narrow Band) based radio technology to connect devices to its global network. The use of UNB is key to providing a scalable, high-capacity network, with very low energy consumption, while maintaining a simple and easy to rollout star-based cell infrastructure.

- **Frequency**
 - Sigfox 868 module: ISM 868 MHz
 - Sigfox 900 module: ISM 900 MHz
- **TX power**
 - Sigfox 868 module: up to 16 dBm
 - Sigfox 900 module: up to 24 dBm
- **ETSI limitation:** 140 messages of 12 bytes, per module per day
- **Range:** Typically, each base station covers some km. Check the [Sigfox network](#).
- **Chipset consumption**
 - Sigfox 868 module: TX 51 mA @ 14 dBm
 - Sigfox 900 module: TX 230 mA @ 24 dBm
- **Radio data rate:** 100 bps
- **Receive sensitivity:** -126 dBm
- **Sigfox certificate:** Class 0u (the highest level)

The network operates in the globally available ISM bands (license-free frequency bands) and co-exists in these frequencies with other radio technologies, but without any risk of collisions or capacity problems.

Sigfox is being rolled out worldwide. It is the responsibility of the system integrator to consult the catalog of [SNOs](#) (Sigfox Network Operators) for checking coverage in the deployment area.

The Sigfox back-end provides a web application interface for device management and configuration of data integration, as well as standards based web APIs to automate the device management and implement the data integration.



Figure: Sigfox network

Related API libraries: **WaspSigfox.h**, **WaspSigfox.cpp**

All information about their programming and operation can be found in the [Sigfox Networking Guide](#).

All the documentation is located in the Development section in the Libelium website.

8.6. WiFi PRO module

The WiFi PRO module offers and supports large variety of features, for example:

- Ten simultaneous TCP/UDP sockets
- DHCP client/server
- DNS client
- HTTP client
- HTTPS client
- FTP client
- NTP client
- Multiple SSIDs
- Roaming mode
- OTA feature. Refer to the Over the Air Programming Guide for more information.

The WiFi PRO module supports the SSL3/TLS1 protocol for secure sockets. On the WLAN interface it supports WEP, WPA and WPA2 WiFi encryption.

The WiFi PRO module may connect to any **standard router** which is configured as Access Point (AP) and then send data to other devices in the same network such as laptops and smart phones. Besides, they can send data directly to a web server located on the Internet.

Instead of using a standard WiFi router as AP, the connection may be performed using a **Meshlium** device as AP. Meshlium is the multiprotocol router designed by Libelium which is specially recommended for outdoor applications as it is designed to resist the hardest conditions in real field deployments. For more information about Meshlium go to: <http://www.libelium.com/meshlium>.

Related API libraries: **WaspWiFi_PRO.h**, **WaspWiFi_PRO.cpp**

All information about their programming and operation can be found in the [WiFi Networking Guide](#).

All the documentation is located in the [Development section](#) in the Libelium website.

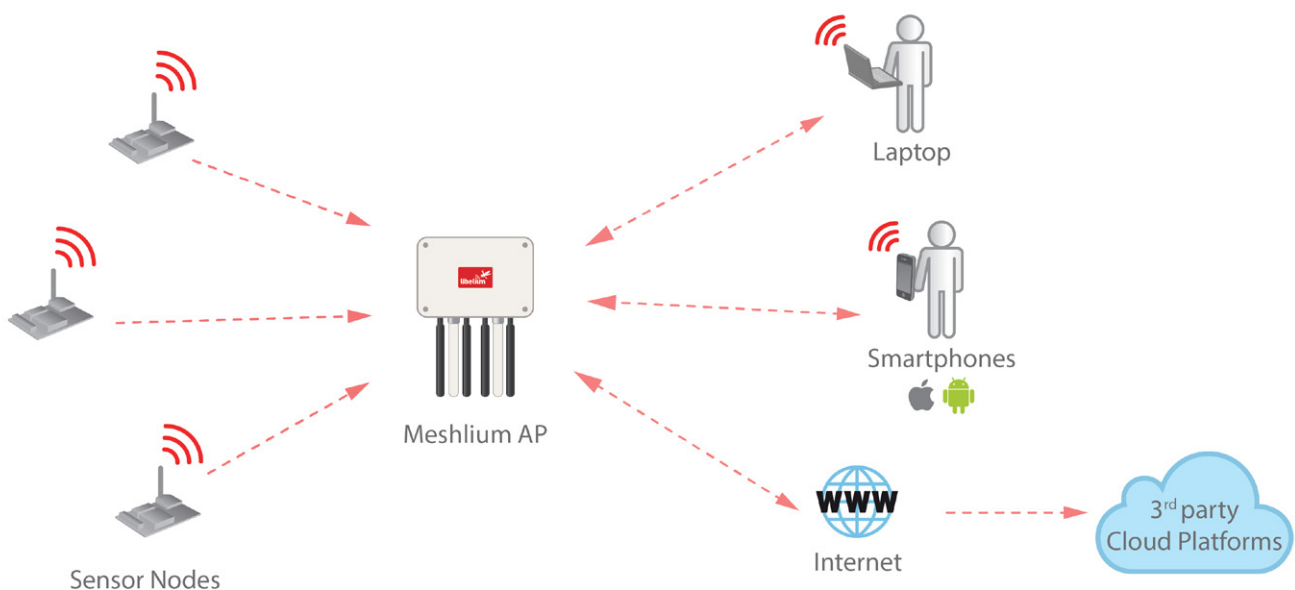

8.7. 4G module

The 4G module enables the connectivity to high speed LTE, HSPA+, WCDMA cellular networks in order to make possible the creation of the next level of worldwide compatible projects inside the new “Internet of Things” era.

This communication module is specially oriented to work with Internet servers, implementing internally several application layer protocols, which make easier to send the information to the cloud. We can make HTTP navigation, downloading and uploading content to a web server. We can also set secure connections using SSL certificates and setting TCP/IP private sockets. In the same way, the FTP protocol is also available which is really useful when your application requires handling files.

The module includes a GPS/GLONASS receiver, able to perform geolocation services using NMEA sentences, offering information such as latitude, longitude, altitude and speed; that makes it perfect to perform tracking applications.

The 4G module offers the maximum performance of the 4G network as it uses 2 different antennas (normal + diversity) for reception (MIMO DL 2x2), choosing the best received signal at any time and getting a maximum download speed of 100 Mbps.

We chose the LE910 chipset family from Telit as it comprises the most complete 4G/LTE set of variants released up to date. It counts with many different models, each one specifically designed for one market but all of them with the same footprint:

- LE910-EU (Europe/Brazil): CE, GCF, ANATEL
- LE910-NAG (US / Canada): FCC, IC, PTCRB, AT&T approved
- LE910-AU V2 (Australia): RCM, Telstra approved → [Available in Q3 2016]

Model: LE910 (Telit)

Versions:

- Europe/Brazil
- America
- Australia

Europe/Brazil version:

- 2G: 900/1800 MHz
- WCDMA: 850/900/2100 MHz
- LTE: 800/1800/2600 MHz

America version:

- 2G: 850/1900 MHz
- WCDMA: 850/1900 MHz
- LTE: 700/850/1700/1900 MHz

Australia version:

- 4G: 700/1800/2600 MHz

LTE (downlink):

- Europe/Brazil version up to 100 Mbps
- America version up to 100 Mbps
- Australia version up to 150 Mbps

LTE (uplink): up to 50 Mbps



TX power:

- Europe/Brazil:
 - Class 4 (2 W, 33 dBm) @ GSM 900
 - Class 1 (1 W, 30 dBm) @ GSM 1800
 - Class E2 (0.5 W, 27 dBm) @ EDGE 900
 - Class E2 (0.4 W, 26 dBm) @ EDGE 1800
 - Class 3 (0.25 W, 24 dBm) @ UMTS
 - Class 3 (0.2 W, 23 dBm) @ LTE
- America:
 - Class 4 (2 W, 33 dBm) @ GSM 900
 - Class 1 (1 W, 30 dBm) @ GSM 1800
 - Class E2 (0.5 W, 27 dBm) @ EDGE 900
 - Class E2 (0.4 W, 26 dBm) @ EDGE 1800
 - Class 3 (0.25 W, 24 dBm) @ UMTS
 - Class 3 (0.2 W, 23 dBm) @ LTE
- Australia:
 - Class 3(0.2W, 23 dBm) @ LTE

Antenna connector:

- U.FL for main antenna
- U.FL for cellular diversity antenna
- U.FL for GPS antenna (only for Europe/Brazil and America modules)

External antenna: +5 dBi

GPS: GPS feature is supported only in Europe/Brazil and America versions

This module can carry out the following tasks:

- Sending/Receiving SMS
- Multisocket up to 6 TCP/IP and UDP/IP clients
- TCP/IP server
- TCP SSL
- HTTP service
- FTP service (downloading and uploading files)
- Sending/receiving email (SMTP/POP3)

This model uses the UART1 at a baudrate of 115200 bps to communicate with the microcontroller.

Related API libraries: **Wasp4G.h**, **Wasp4G.cpp**

All information about programming and operation can be found in the [4G Networking Guide](#).

All the documentation is located in the [Development section](#) of Libelium website.

Note: A rechargeable battery must be always connected when using this module (USB power supply is not enough).

9. Industrial Protocols

As an optional feature, it is possible to incorporate an Industrial Protocol module as a secondary communication module, besides the main radio interface of Wasp mote Plug & Sense!.

The available Industrial Protocols are RS-232, RS-485, CAN Bus and Modbus (software layer over RS-232 or RS-485). This optional feature is accessible through an additional and dedicated socket on the antenna side of the enclosure.

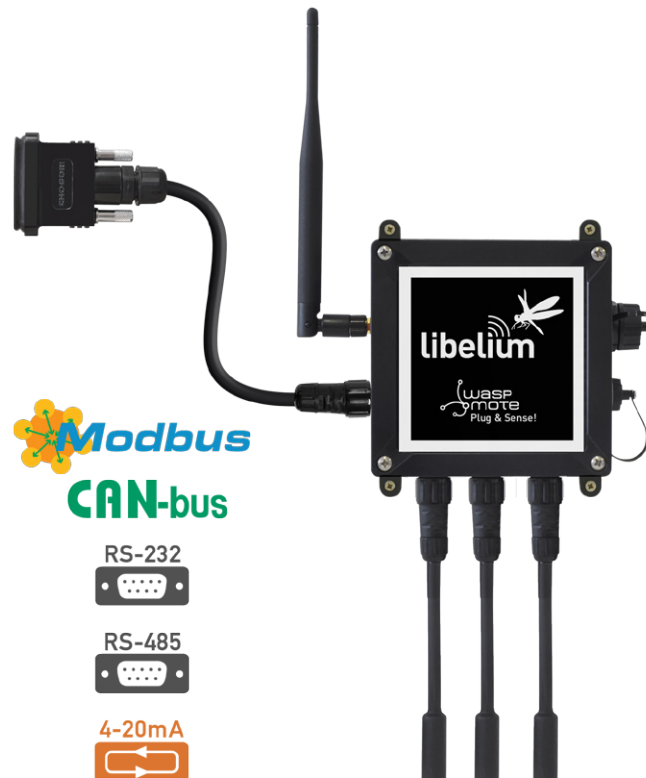

Figure: Industrial Protocols available on Plug & Sense!

The user can choose between 2 probes to connect the desired Industrial Protocol: A standard DB9 connector and a waterproof terminal block junction box. These options make the connections on industrial environments or outdoor applications easier.



Figure: DB9 probe connected to Plug & Sense!



Figure: Terminal box probe connected to Plug & Sense!

Each Industrial Protocol requires its own signals, wired on the female DB9 connector and on the Terminal box according to the next table:

RS-232		RS-485		CAN Bus		
Terminal Box	DB9	Terminal Box	DB9	Terminal Box	DB9	
-	-	-	-	-	-	1
RX	RX	-	-	-	-	2
TX	TX	DATA + (A)	DATA + (A)	CAN_H	CAN_H	3
-	-	DATA - (B)	DATA - (B)	-	-	4
GND	GND	-	-	CAN_L	CAN_L	5
-	-	-	-	-	-	6
-	-	-	-	-	-	7
-	-	-	-	-	-	8
-	-	-	-	-	-	9

Figure: Wiring of Industrial Protocol signals on Plug & Sense!

10. GPS module

Any Plug & Sense! node can incorporate a GPS receiver in order to implement real-time asset tracking applications. The user can also take advantage of this accessory to geolocate data on a map. An external, waterproof antenna is provided; its long cable enables better installation for maximum satellite visibility.



Figure: Plug & Sense! node with GPS receiver

Chipset: JN3 (Telit)

Sensitivity:

- Acquisition: -147 dBm
- Navigation: -160 dBm
- Tracking: -163 dBm

Hot start time: <1 s

Cold start time: <35 s

Positional accuracy error < 2.5 m

Speed accuracy < 0.01 m/s

EGNOS, WAAS, GAGAN and MSAS capability

Antenna:

- Cable length: 2 m
- Connector: SMA
- Gain: 26 dBi (active)

Available information: latitude, longitude, altitude, speed, direction, date&time and ephemeris management

11. Internal storage

Waspote Plug & Sense! has an internal SD (Secure Digital) card. FAT32 file system is used and cards up to 8 GB are supported.

Note: *Until February 2018, 2 GB SD cards were distributed; they operated with FAT16.*

To get an idea of the capacity of information that can be stored in a 8 GB card, simply divide its size by the average for what a sensor frame in Waspote usually occupies (approx. 100 bytes):

$$8 \text{ GB} / 100 \text{ B} = 80 \text{ million measurements}$$

The limit in files and directories creation per level is 256 files per directory and up to 256 sub-directories in each directory. There is no limit in the number of nested levels.

The SD card is also used to store the firmware image when performing Over the Air Programming (OTAP).

All information about their programming and operation can be found in the [SD Card Programming Guide](#).

Note: *Waspote must not be switched off or reset while there are ongoing read or write operations in the SD card. Otherwise, the SD card could be damaged and data could be lost.*

12. On/off button

This button is used to turn on or off Waspote. It is a latch type button with two static positions as shown below. In on position, the button remains a bit lower than the LED ring.



Figure: On/off button at off position



Figure: Turning on Waspote

Note: The on/off button can be in on or off position to charge the battery.

Note: Also, RTC time is now kept correctly even if the button is turned to off position.

12.1. External LED

The on/off button includes a red ring LED, which can be managed by software using dedicated functions described below. This LED can be used for instance to know that Waspote is on, or for debugging purposes at developing phase. By default, Waspote Plug & Sense! comes with a code that blinks briefly (3 times in less than one second) this LED when it is turned on. The LED can be managed specifying on time or just setting this state with specific API functions. The user should take into account that the usage of this LED will increase power consumption due to external LED consumes 4.4 mA.



Figure: Waspote turned on

External LED ring can be managed with next code lines:

```
Utils.setExternalLED(LED_ON); // Turns external led ON  
Utils.setExternalLED(LED_OFF); // Turns external led OFF
```

There is also another useful function which blinks external LED during specified time.

```
Utils.externalLEDBlink(uint_16 time) // Time must be in seconds
```

Finally, there is an extra function to know the external LED state:

```
Utils.getExternalLED(); // Read external led state
```

13. Resetting Waspote Plug & Sense! with an external magnet

Waspote Plug & Sense! can be reset with an external magnet, with no contact. If one node stops working or if a defective behavior is detected, it would be costly to uninstall the node to bring it back to laboratory. This feature allows the network manager to reset the node in a quick and easy way.

The hardware consists of a reed switch connected to the Waspote reset line. When the user gets the magnet close to the reed-switch, the reset is activated. When the user moves the magnet away, the reset line is released (the external LED will blink) and Waspote executes the bootloader first and then, the setup function. After the setup, it will continue with the loop function. Next pictures show the right way to reset the node using an external magnet, first moving it closer, and then moving it away.



Figure: Moving the magnet closer to the node



Figure: Moving the magnet away from the node

The magnet is made of neodymium. It is a special, high-power magnet. We only advise to use the magnet Libelium provides. The user must be careful because the magnet is so powerful that it can get stuck to metal objects. Besides, the magnet must be kept away from electronic devices like PCs, batteries, etc, since they could be damaged or information could be deleted.

It is not mandatory, but highly recommended to consider this feature when designing the project. Every Plug & Sense! node comes with the hardware to allow the contactless reset, but the magnet is optional, an accessory. It is highly recommended to purchase one magnet (one unit is enough for many nodes). The user should design the software in a way the node can be reset if things go wrong. Remember that laboratory tests are always needed to validate the feature before your final deployment.

When the node is already deployed in the field, and for instance it is installed in a traffic light, this feature can be used to reset the node easily, as it is shown in the diagram below, where a technician uses a pole with the magnet attached in one side.

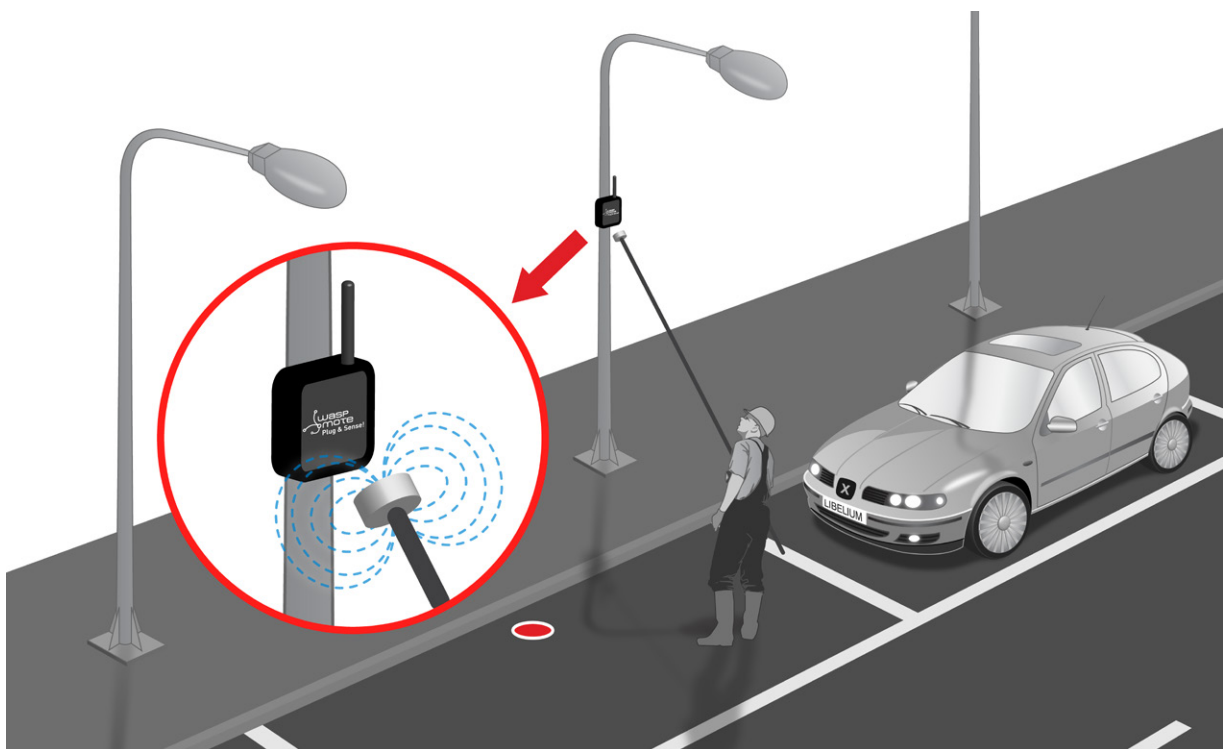

Figure: Resetting a Plug & Sense! node with a pole and magnet

14. USB port

This connector is used to upload code into Wasp mote with a male to male USB cable provided by Libelium. Also, Plug & Sense! sends messages via this USB port. Just connect one side of the cable to this connector, removing protection cap and connect the other side to a PC to upload a code or to charge the internal rechargeable battery. Next picture shows an example.



Figure: USB connector and protective cap



Figure: Connecting the USB cable to Wasp mote

When uploading processes are finished, do not forget to screw firmly the protection cap to avoid connector damage. Never connect a USB which exceed maximum ratings of USB standard.



Figure: Connecting USB charger

For indoor deployments the nodes can be recharged using the USB charger.



Figure: Charging the mote via USB

14.1. Outdoors USB Cable

The Outdoors USB Cable is made for outdoors applications with high power consumption requirements, where nodes need to be permanently powered. It consists of a 3-meter cable with the solar socket connector on one end, and a USB male A type on the other end.

The solar socket end is meant to be connected on the solar socket of Plug & Sense!, it is not valid for the sensor sockets. This special end is waterproof and suitable for outdoors connections.

On the other hand, the USB end of the cable is thought to be connected to the USB charger (AC/DC, 5 V output). Bear in mind that this end is not waterproof so it cannot be used outdoors. Please protect it accordingly.



Figure: Outdoors USB Cable

One application of the cable is to power a node placed on the facade of a building; the USB cable goes indoors through a nearby window, and the USB end remains indoors, connected to a wall adapter.

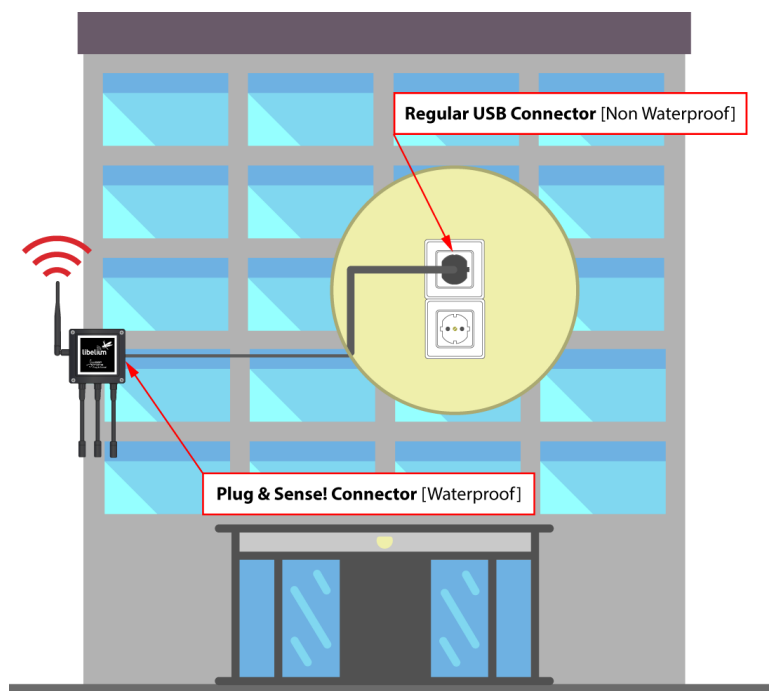

Figure: Application of the Outdoors USB Cable

14.2. External SIM/USB socket

The External SIM/USB socket replaces the USB socket in two types of devices:

- WaspMote Plug & Sense! devices with **4G module**
- Meshlium devices with 4G module

The External SIM/USB socket is composed of 2 connectors:

- nano-SIM card
- micro-USB (type B)



Figure: External SIM/USB socket in a Plug & Sense! with 4G module

The operation with the micro-USB socket is just the same than with the normal USB socket. Just remember to use a micro-USB cable.



Figure: Connecting the micro-USB cable to Plug & Sense!

The nano-SIM card connector allows the user to connect the SIM card he likes from the outside. It is not necessary to send a SIM card to Libelium for proper installation. You can ask your telecommunication provider for a nano-SIM card. Alternatively you can take a normal SIM card and transform it into a nano-SIM card with a SIM card cutter.

Besides, the nano-SIM card connector has a push-push mechanism, so it is really easy to remove the card with the aid of one nail.



Figure: Push-push mechanism in the External SIM/USB socket

Please mind the correct orientation of the nano-SIM card: the side of the chip must look towards the micro-USB connector, and the 45°-angled corner must face the device.

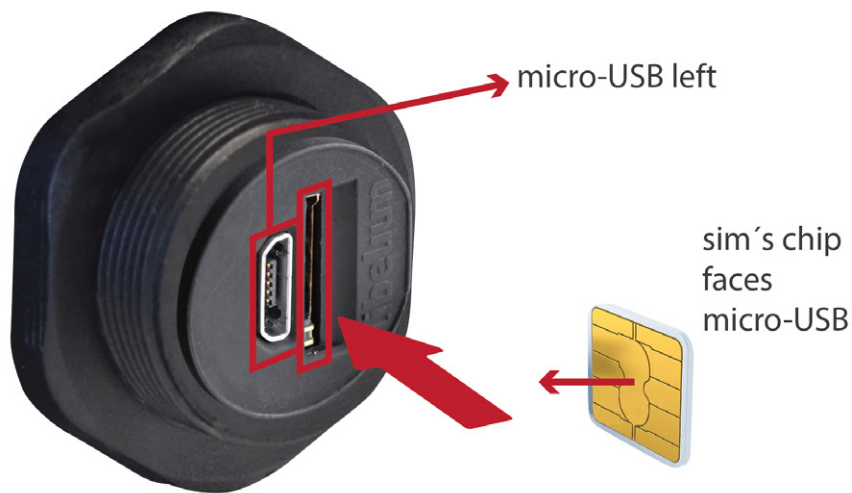

Figure: Correct orientation of the nano-SIM card

It is highly important to turn off the Plug & Sense! device in a secure way before inserting a SIM card, or removing an existing SIM-card. The user can damage the device if this operation is done "on-the-fly".

Make sure you closed the External SIM/USB socket with its protection cap before outdoors deployment.

IMPORTANT: Take into account that the External SIM/USB socket has a limited resistance. Do not push it hard with the USB or SIM card.



Figure: Inserting a SIM card with care in the External SIM/USB socket

Note: From February 2018, Libelium has redesigned the SIM-USB connector, now it is more resistant and we have updated it using the most popular SIM card standard, nano-SIM.

15. External solar panel

This panel should be connected to the external solar panel connector. As shown in picture below, it has identical shape as sensor connectors, but is placed on the control side of the enclosure, below the on/off button.

External solar panel features:

- **Max power:** 3 W
- **Max power voltage:** 5.8 V
- **Max power current:** 520 mA (max current input is 300 mA in Plug & Sense!)
- **Dimensions:** 234 x 160 x 17 mm
- **Weight:** 0.54 kg



Figure: External solar panel connector

Do not connect any sensor on this connector and also do not connect the solar panel to a sensor connector. Wasp mote can be damaged and warranty will be void.



Figure: Connecting the solar panel to Wasp mote Plug & Sense!

In the next picture a typical installation with external solar panel is shown. Notice that the enclosure is placed just under the solar panel, using it as a protection against sun and rain.

Libelium provides special brackets in order to install it correctly.



Figure: Typical installation of the external solar panel

16. External Battery Module

The External Battery Module (EBM) is an accessory to extend the battery life of Plug & Sense!. The extension period may be from months to years depending on the sleep cycle and radio activity. The daily charging period is selectable among 5, 15 and 30 minutes with a selector switch and it can be combined with a solar panel to extend even more the node's battery lifetime.

Typical scenarios for this accessory are remote places where a power supply is not available or places where a solar panel is not suitable, like tunnels or cloudy environments.

Note: Nodes using solar panel can keep using it through the External Battery Module (EBM). The EBM is connected to the solar panel connector of Plug & Sense! and the solar panel unit is connected to the solar panel connector of the EBM.

16.1. Technical specifications

- 26 A·h high performance non-rechargeable battery
- Dimensions: 122 mm x 82 mm x 84 mm (without mounting feet)
- Operating temperature range: -30 °C to 70 °C*
- Low self-discharge rate
- IP65 waterproof, polycarbonate enclosure
- On/Off switch
- Operating mode selector (3 different modes)
- Solar panel voltage: up to 18 V
- 2 different solar panel options available

* Temporary extreme temperatures are supported. Regular recommended usage: -20, +60 °C.

The EBM is specially designed to minimize its power consumption and maximizing its efficiency and the energy delivered to the node. This way, the internal electronic is in an ultra-low power state most of the time. The pictures below show a general view of the EBM main parts.

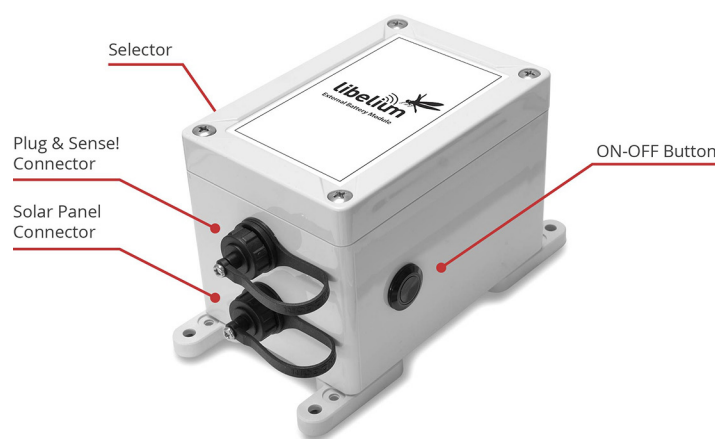

Figure: External Battery Module

As shown above, the EBM has 2 sockets: One for the solar panel and one for the Plug & Sense! node. An extension cord will be used to connect the EBM and the node.



Figure: External Battery Module's Plug & Sense! connector



Figure: Plug & Sense! with External Battery Module

A solar panel can be attached to the solar panel connector, providing extra energy to the Plug & Sense! and extending the EBM life. Furthermore, if the charging period occurs while the solar panel is providing energy, the EBM will only provide the necessary current to fulfill the demand of the Plug & Sense! node. If the solar panel is able to provide all the current demand, the EBM will not contribute during the charging process. This way, the system does not waste energy from the solar panel and, at the same time, it enlarges the EBM battery lifetime.



Figure: External Battery Module with a solar panel connected



Figure: Plug & Sense! with External Battery Module and solar panel

Finally, the EBM is compatible with all the Plug & Sense! product range, but it is not compatible with other Libelium products like Meshlium, Smart Parking or MySignals.

16.2. Operating modes

The EBM is designed to charge a Plug & Sense! node once per day during a preprogrammed period of time.

There is a latch button to turn on and off the EBM. This button also includes a red LED to show the user when the device has started working. It will blink only a couple of times when the device is switched on, to avoid unnecessary current consumption through it. When the device is on, the button will look like in the picture below.



Figure: External Battery Module, on position

Due to the nature of the EBM battery, its level cannot be monitored. If the LED does not blink when the button is pressed, the EBM battery could be empty. On the other hand, when the button is off, the battery is physically disconnected from any circuitry and there is no power consumption from the battery, even if there is a solar panel present. Finally, the LED will not be on during the charging period for efficiency purposes.

The External Battery Module has 3 operating modes. In order to select them, there is a 3-position rotative selector switch.

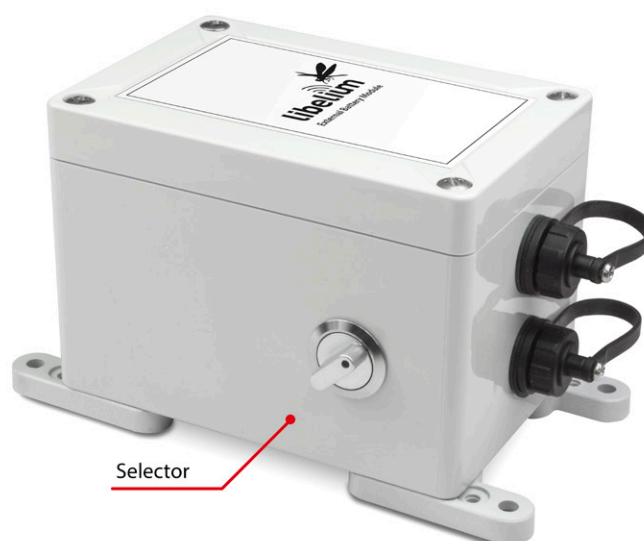

Figure: External Battery Module operation selector

The operating mode determines the daily time that the system will be charging a node:

- Position 1 will set the charging time to 5 minutes per day
- Position 2 will set the charging time to 15 minutes per day
- Position 3 will set the charging time to 30 minutes per day

During the charging period, the Plug & Sense! node will be recharged at the maximum charging current, which is 300 mA. The operating mode must be selected before turning on the EBM. The selector will be read just after turning on the device and the button LED will blink accordingly to the selected mode (one blink for position 1, 2 blinks for position 2 and so on). **If the mode needs to be changed, it is necessary to turn off the EBM first, otherwise moving the selector will not have any effect.** Moreover, it has to be taken into account that temperature variations might induce small time drifts due to the tolerance of the internal electronic components.

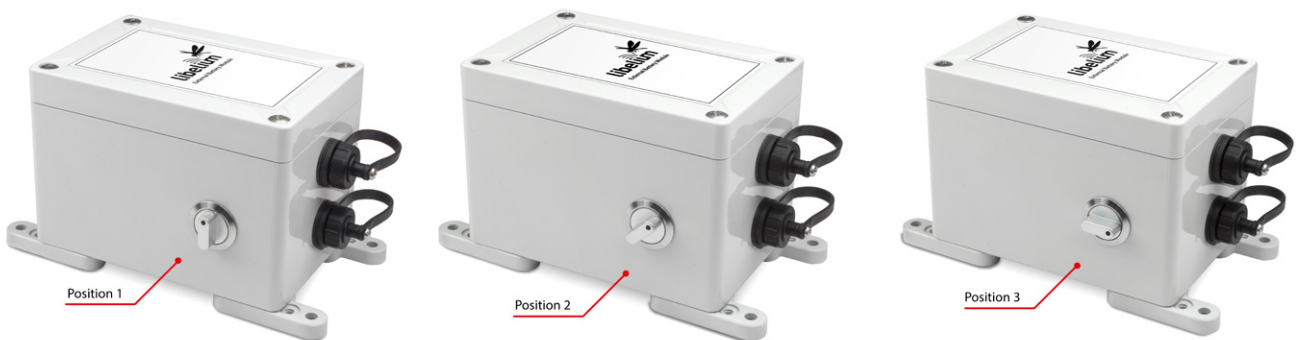

Figure: Selector on the 3 different positions

If the Plug & Sense! charging current needs to be monitored, please use the example [power 06: battery recharging](#). The current flow through the Plug & Sense! solar panel connector will be printed on screen. Besides, take into account that **the EBM will start the selected charging period 5 minutes after turning it on.**

As can be inferred from the previous lines, the EBM battery life will be larger in position 1 than in position 3. To estimate the battery life, consider that the maximum allowed charging current through the Plug & Sense! solar panel connector is 300 mA (it becomes smaller when the Plug & Sense! battery is near to 100%). Moreover, take into account that environmental conditions like temperature or the battery self-discharge may affect also to the EBM lifetime.

17. Vent plug / Pressure Compensator

The purpose of the Vent Plug is to avoid condensation by compensating external / internal pressure. Do not try to connect anything to this element and also do not modify its position or any of its parts.



Figure: Vent plug of Wasp mote Plug & Sense!

18. Antenna

By default, Waspote Plug & Sense! has one external antenna with a standard SMA connector. This connector allows to connect the RF antenna. See next section for more information about other antenna options.



Figure: Antenna connector of the enclosure

To ensure good RF coverage, be sure that the antenna points to the sky and also be sure that the antenna is screwed completely to the connector. To connect the antenna, just align it with the connector and screw it carefully. Antenna must be always connected in order to ensure a good RF communication.



Figure: Connecting antenna to the enclosure

Note: Once Waspote Plug & Sense! is installed, it is recommended to fix it using a tape like the one shown in the picture below.



Figure: Recommended tape



Figure: Ensure antenna remains in the right position

Do not try to connect other kind of antennas which do not match with SMA standard connector and also other antennas not provided by Libelium.

18.1. Antennas for the Plug & Sense! 4G model

The Waspote Plug & Sense! models including a 4G radio will have 3 antenna connectors: the cellular main antenna, the cellular diversity antenna and the GPS antenna. The antenna to be connected is the same on the 3 cases. See the pictures below to identify each 4G antenna connector. The 3 antennas must be properly connected for the right operation of the 4G radio.



Figure: Main and GPS antennas (only 4G models)

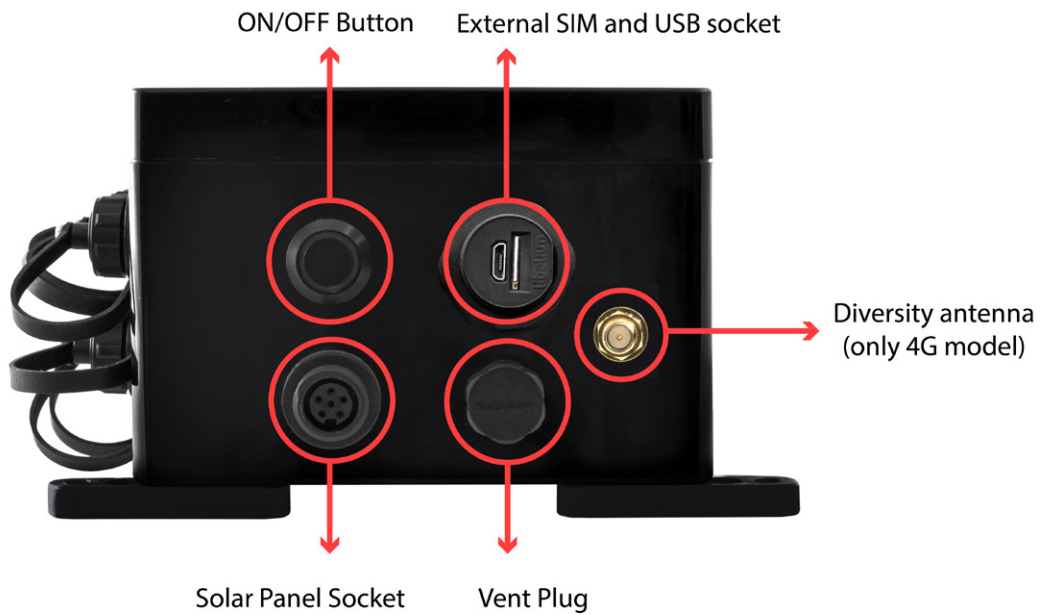

Figure: Diversity antenna (only 4G models)

Note: The 4G radio for Australia does not have a GPS receiver, so in this case, only 2 antennas are provided. Just leave the GPS antenna connector without any antenna.

18.2. Antennas for Plug & Sense! GPS-ready models

The Wasp Mote Plug & Sense! models including a GPS receiver will have 3 antenna connectors: the main radio antenna connector, the GPS antenna connector and an unused antenna connector. The GPS antenna and the main antenna are different. The GPS antenna is easy to identify: it is a square and magnetic antenna with a long cable (2 m). See the pictures below to identify each GPS antenna connector.

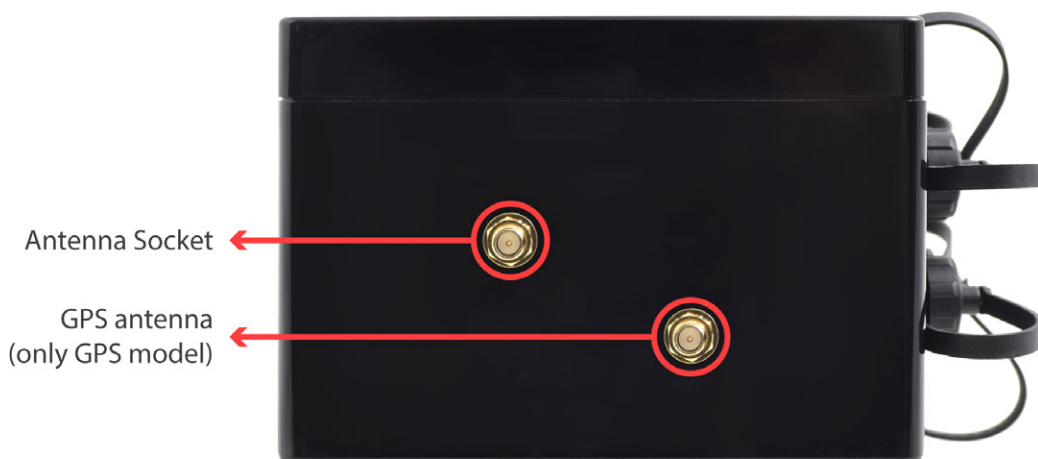

Figure: Main and GPS antennas connectors (only GPS-ready models)

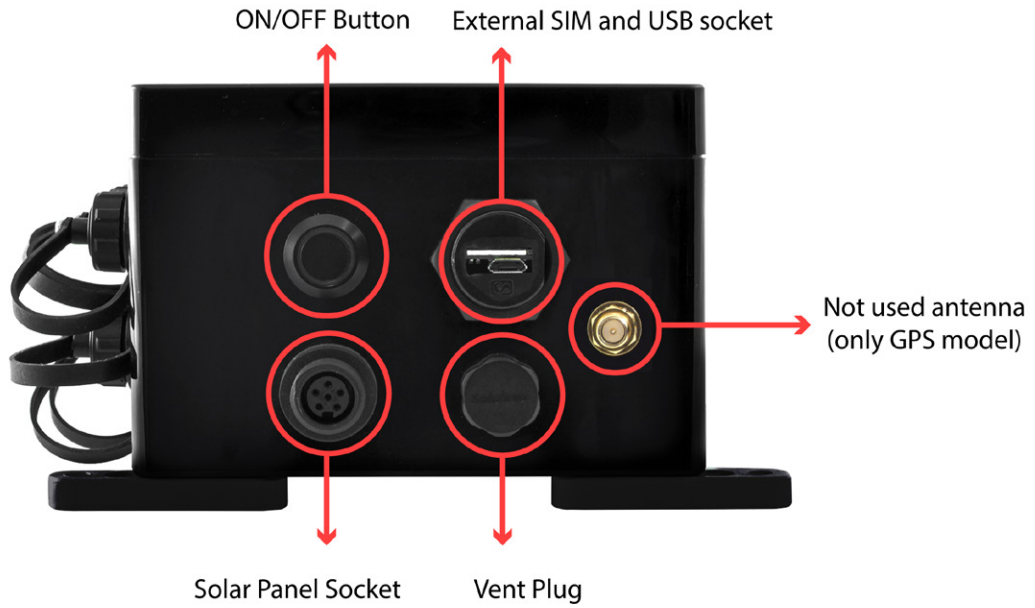

Figure: Not used antenna connector (only GPS-ready models)

Note: In order to achieve a better performance and maximum satellite visibility, the GPS antenna should be placed in an open-space location and oriented so that its reference arrow points vertically to the sky.

19. Sensor protection

19.1. Special probes

There are some sensor probes which include special protection against sunlight and bad environmental conditions. For instance, the temperature, humidity and pressure probe has a special filter which allows humidity measurement but offers protection against water.

However, a lot of sensor probes include just a standard protection. If the final application involves bad environmental conditions and a lot of sunlight hours, Libelium suggests the usage of a solar radiation shield.

In addition, refer to corresponding section for more information about sensor probes.

20. Battery

Libelium provides a 6600 mA·h rechargeable battery inside Waspote Plug & Sense!.

Waspote has a control and safety circuit which makes sure the battery charge current is always adequate. The following image shows a battery discharging for a typical load and for a specific case.

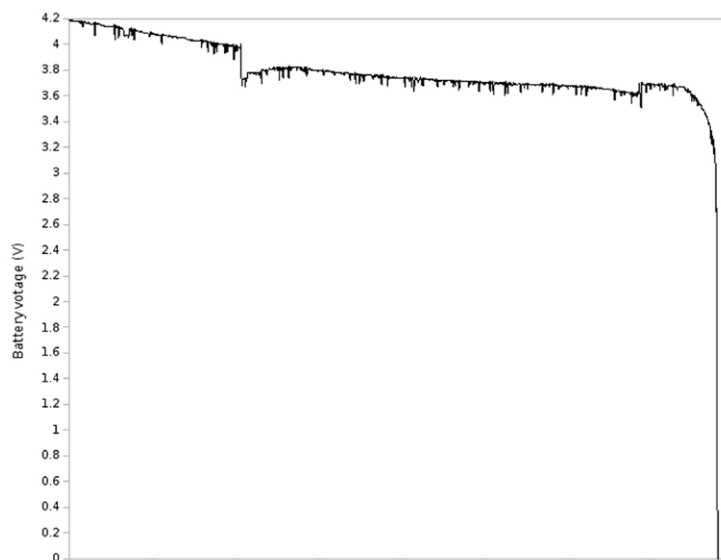

Figure: Typical discharging curve for the 6600 mA·h battery

Note: When recharging, if the battery is near 0%, it will take some time before the battery level increases.

Note: It is normal to see some battery level variations during the charging periods due to the Waspote charging circuitry. To know the real battery level of the node, it is recommended to measure it when the node is not being recharged and also with sensors and radio modules switched off.

Note: The on/off button can be in on or off position to charge the battery.

21. Models

There are some defined configurations of Waspote Plug & Sense! depending on which sensors are going to be used. Waspote Plug & Sense! configurations allow to connect up to six sensor probes at the same time.

Each model takes a different conditioning circuit to enable the sensor integration. For this reason each model allows to connect just its specific sensors. In the next table we show the sensor board which corresponds to each Plug & Sense! model:

Plug & Sense! model	Waspote OEM sensor board
Plug & Sense! Smart Environment PRO	Gases PRO Sensor Board
Plug & Sense! Smart Agriculture	Smart Agriculture Sensor Board
Plug & Sense! Smart Agriculture PRO	Smart Agriculture PRO Sensor Board
Plug & Sense! Smart Water	Smart Water Sensor Board
Plug & Sense! Smart Water Ions	Smart Water Ions Sensor Board
Plug & Sense! Smart Cities PRO	Smart Cities PRO Sensor Board
Plug & Sense! Ambient Control	No sensor board inside (direct connection)
Plug & Sense! Smart Security	Events Sensor Board
Plug & Sense! Radiation Control	Radiation Sensor Board
Plug & Sense! 4-20 mA Current Loop	4-20 mA Current Loop Sensor Board

This section describes each model configuration in detail, showing the sensors which can be used in each case and how to connect them to Waspote. In many cases, the sensor sockets accept the connection of more than one sensor probe. See the compatibility table for each model configuration to choose the best probe combination for the application.

It is very important to remark that each socket is designed only for one specific sensor, so **they are not interchangeable**. Always be sure you connected probes in the right socket, otherwise they can be damaged.

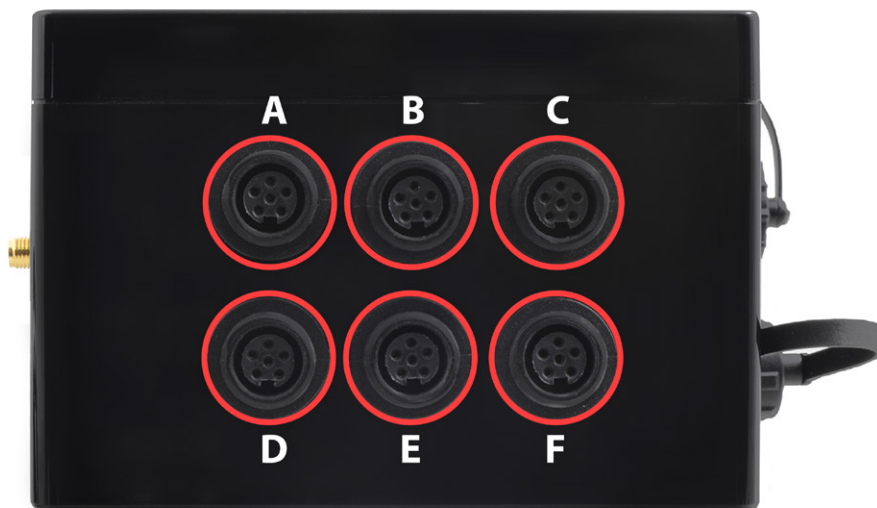

Figure: Identification of sensor sockets

21.1. Smart Environment PRO

The Smart Environment PRO model has been created as an evolution of Smart Environment. It enables the user to implement pollution, air quality, industrial, environmental or farming projects with high requirements in terms of high accuracy, reliability and measurement range as the sensors come calibrated from factory.



Figure: Smart Environment PRO Waspnote Plug & Sense! model

Sensor sockets are configured as shown in the figure below.

Sensor Socket	Sensor probes allowed for each sensor socket	
	Parameter	Reference
A, B, C or F	Carbon Monoxide (CO) for high concentrations [Calibrated]	9371-P
	Carbon Monoxide (CO) for low concentrations [Calibrated]	9371-LC-P
	Carbon Dioxide (CO ₂) [Calibrated]	9372-P
	Oxygen (O ₂) [Calibrated]	9373-P
	Ozone (O ₃) [Calibrated]	9374-P
	Nitric Oxide (NO) for low concentrations [Calibrated]	9375-LC-P
	Nitric Dioxide (NO ₂) high accuracy [Calibrated]	9376-HA-P
	Sulfur Dioxide (SO ₂) high accuracy [Calibrated]	9377-HA-P
	Ammonia (NH ₃) for low concentrations [Calibrated]	9378-LC-P
	Ammonia (NH ₃) for high concentrations [Calibrated]	9378-HC-P
	Methane (CH ₄) and Combustible Gas [Calibrated]	9379-P
	Hydrogen (H ₂) [Calibrated]	9380-P
	Hydrogen Sulfide (H ₂ S) [Calibrated]	9381-P
	Hydrogen Chloride (HCl) [Calibrated]	9382-P
	Hydrogen Cyanide (HCN) [Calibrated]	9383-P
	Phosphine (PH ₃) [Calibrated]	9384-P
	Ethylene (ETO) [Calibrated]	9385-P
Chlorine (Cl ₂) [Calibrated]	9386-P	
D	Particle Matter (PM1 / PM2.5 / PM10) - Dust	9387-P
E	Temperature, humidity and pressure	9370-P
	Luminosity (Luxes accuracy)	9325-P
	Ultrasound (distance measurement)	9246-P

Figure: Sensor sockets configuration for Smart Environment PRO model

Note: For more technical information about each sensor probe go to the [Development section](#) on the Libelium website.

Calibrated gas sensors are manufactured once the order has been placed to ensure maximum durability of the calibration feature. The manufacturing process and delivery may take from 4 to 6 weeks. The lifetime of calibrated gas sensors is 6 months working at maximum accuracy. We strongly encourage our customers to buy extra gas sensors to replace the original ones after that time to ensure maximum accuracy and performance.

Note: *In March 2017, Smart Environment (which is the Plug & Sense! version for the Gases sensor board) was discontinued. The Gases sensor board is now only available in the Waspote OEM product line. Libelium currently offers Gases PRO (Smart Environment PRO) and Smart Cities PRO for accurate measuring of gases.*

21.2. Smart Security

The main applications for this Waspmote Plug & Sense! configuration are perimeter access control, liquid presence detection and doors and windows openings. Besides, a relay system allows this model to interact with external electrical machines.



Figure: Smart Security Waspmote Plug & Sense! model

Note: The probes attached in this photo could not match the final location. See next table for the correct configuration.

Sensor Socket	Sensor probes allowed for each sensor socket	
	Parameter	Reference
A, C, D or E	Temperature + Humidity + Pressure	9370-P
	Luminosity (Luxes accuracy)	9325-P
	Ultrasound (distance measurement)	9246-P
	Presence - PIR	9212-P
	Liquid Level (combustible, water)	9239-P, 9240-P
	Liquid Presence (Point, Line)	9243-P, 9295-P
	Hall Effect	9207-P
B	Liquid Flow (small, medium, large)	9296-P, 9297-P, 9298-P
F	Relay Input-Output	9270-P

Figure: Sensor sockets configuration for Smart Security model

As we see in the figure below, thanks to the directional probe, the presence sensor probe (PIR) may be placed in different positions. The sensor can be focused directly to the point we want.



Figure: Configurations of the Presence sensor probe (PIR)

Note: For more technical information about each sensor probe go to the [Development section](#) on the Libelium website.

21.3. Smart Water

The Smart Water model has been conceived to facilitate the remote monitoring of the most relevant parameters related to water quality. With this platform you can measure more than 6 parameters, including the most relevant for water control such as dissolved oxygen, oxidation-reduction potential, pH, conductivity and temperature. An extremely accurate turbidity sensor has been integrated as well.

The Smart Water Ions line is complementary for these kinds of projects, enabling the control of concentration of ions like Ammonium (NH_4^+), Bromide (Br^-), Calcium (Ca^{2+}), Chloride (Cl^-), Cupric (Cu^{2+}), Fluoride (F^-), Iodide (I^-), Lithium (Li^+), Magnesium (Mg^{2+}), Nitrate (NO_3^-), Nitrite (NO_2^-), Perchlorate (ClO_4^-), Potassium (K^+), Silver (Ag^+), Sodium (Na^+) and pH. Take a look to the Smart Water Ions line in the next section.

Refer to [Libelium website](#) for more information.



Figure: Smart Water Plug&Sense! model

Sensor sockets are configured as shown in the figure below.

Sensor Socket	Sensor probes allowed for each sensor socket	
	Parameter	Reference
A	pH	9328
B	Dissolved Oxygen (DO)	9327
C	Conductivity	9326
E	Oxidation-Reduction Potential (ORP)	9329
F	Soil/Water Temperature	9255-P (included by default)
	Turbidity	9353-P

Figure: Sensor sockets configuration for Smart Water model

Note: For more technical information about each sensor probe go to the [Development section](#) on the Libelium website.

21.4. Smart Water Ions

The Smart Water Ions models specialize in the measurement of ions concentration for drinking water quality control, agriculture water monitoring, swimming pools or waste water treatment.

The Smart Water line is complementary for these kinds of projects, enabling the control of parameters like turbidity, conductivity, oxidation-reduction potential and dissolved oxygen. Take a look to the Smart Water line in the previous section. Refer to Libelium website for more information.

There are 3 variants for Smart Water Ions: Single, Double and PRO. This is related to the type of ion sensor that each variant can integrate. Next section describes each configuration in detail.



Figure: Smart Water Ions WaspMote Plug & Sense! model

21.4.1. Single

This variant includes a Single Junction Reference Probe, so it can read all the single type ion sensors. Sensor sockets are configured as shown in the table below.

Sensor Socket	Sensor probes allowed for each sensor socket	
	Parameter	Reference
A, B, C and D	Calcium Ion (Ca^{2+})	9352
	Fluoride Ion (F)	9353
	Fluoroborate Ion (BF_4^-)	9354
	Nitrate Ion (NO_3^-)	9355
	pH (for Smart Water Ions)	9363
E	Single Junction Reference	9350 (included by default)
F	Soil/Water Temperature	9255-P (included by default)

Figure: Sensor sockets configuration for Smart Water Ions model, single variant

Note: For more technical information about each sensor probe go to the [Development section](#) on the Libelium website.

21.4.2. Double

This variant includes a Double Junction Reference Probe, so it can read all the double type ion sensors. Sensor sockets are configured as shown in the table below.

Sensor Socket	Sensor probes allowed for each sensor socket	
	Parameter	Reference
A, B, C and D	Bromide Ion (Br^-)	9356
	Chloride Ion (Cl^-)	9357
	Cupric Ion (Cu^{2+})	9358
	Iodide Ion (I^-)	9360
	Silver Ion (Ag^+)	9362
	pH (for Smart Water Ions)	9363
E	Double Junction Reference	9351 (included by default)
F	Soil/Water Temperature	9255-P (included by default)

Figure: Sensor sockets configuration for Smart Water Ions model, double variant

Note: For more technical information about each sensor probe go to the [Development section](#) on the Libelium website.

21.4.3. Pro

This special variant integrates extreme quality sensors, with better performance than the Single or Double lines. In this case, there is only one type of reference probe and up to 16 different ion parameters can be analyzed in 4 sockets.

Sensor sockets are configured as shown in the table below.

Sensor Socket	Sensor probes allowed for each sensor socket	
	Parameter	Reference
A, B, C or D	Ammonium Ion (NH ₄ ⁺) [PRO]	9412
	Bromide Ion (Br ⁻) [PRO]	9413
	Calcium Ion (Ca ²⁺) [PRO]	9414
	Chloride Ion (Cl ⁻) [PRO]	9415
	Cupric Ion (Cu ²⁺) [PRO]	9416
	Fluoride Ion (F ⁻) [PRO]	9417
	Iodide Ion (I ⁻) [PRO]	9418
	Lithium Ion (Li ⁺) [PRO]	9419
	Magnesium Ion (Mg ²⁺) [PRO]	9420
	Nitrate Ion (NO ₃ ⁻) [PRO]	9421
	Nitrite Ion (NO ₂ ⁻) [PRO]	9422
	Perchlorate Ion (ClO ₄ ⁻) [PRO]	9423
	Potassium Ion (K ⁺) [PRO]	9424
	Silver Ion (Ag ⁺) [PRO]	9425
	Sodium Ion (Na ⁺) [PRO]	9426
pH [PRO]	9411	
E	Reference Sensor Probe [PRO]	9410 (included by default)
F	Soil/Water Temperature	9255-P (included by default)

Figure: Sensor sockets configuration for Smart Water Ions model, PRO variant

Note: For more technical information about each sensor probe go to the [Development section](#) on the Libelium website.

21.5. Smart Parking

The Smart Parking node allows to detect available parking spots by placing the node on the pavement. It works with a magnetic sensor which detects when a vehicle is present or not.

The node benefits from Sigfox and LoRaWAN technologies (868 and 900 MHz bands), getting ubiquitous coverage with few base stations. The device is very optimized in terms of power consumption, resulting in a long battery life. Its small size and the robust and surface-mount enclosure enables a fast installation, without the need of digging a hole in the ground. Finally, the developer does not need to program the node, but just configure some key parameters. Remote management and bidirectional communication allow to change parameters from the Cloud.



Figure: Smart Parking node

Note: There are specific documents for parking applications on the Libelium website. Refer to the Smart Parking Technical Guide to see typical applications for this model and how to make a good installation.



Figure: Smart Parking application diagram

21.6. Smart Agriculture

The Smart Agriculture models allow to monitor multiple environmental parameters involving a wide range of applications. It has been provided with sensors for air and soil temperature and humidity, solar visible radiation, wind speed and direction, rainfall, atmospheric pressure, etc.

The main applications for this Waspmote Plug & Sense! model are precision agriculture, irrigation systems, greenhouses, weather stations, etc. Refer to [Libelium website](#) for more information.

Two variants are possible for this model, normal and PRO. Next section describes each configuration in detail.



Figure: Smart Agriculture Waspmote Plug & Sense! model

21.6.1. Normal

Sensor sockets are configured as shown in the figure below.

Sensor Socket	Sensor probes allowed for each sensor socket	
	Parameter	Reference
A	Weather Station WS-3000 (anemometer + wind vane + pluviometer)	9256-P
B	Soil Moisture 1	9248-P, 9324-P, 9323-P
C	Soil Moisture 3	9248-P, 9324-P, 9323-P
D	Soil Temperature	86949-P
	Temperature + Humidity + Pressure	9370-P
	Luminosity (Luxes accuracy)	9325-P
	Ultrasound (distance measurement)	9246-P
E	Leaf Wetness	9249-P
	Soil Moisture 2	9248-P, 9324-P, 9323-P
F (digital bus)	Temperature + Humidity + Pressure	9370-P
	Luminosity (Luxes accuracy)	9325-P
	Ultrasound (distance measurement)	9246-P

Figure: Sensor sockets configuration for Smart Agriculture model

Note: For more technical information about each sensor probe go to the [Development section](#) on the Libelium website.

21.6.2. PRO

Sensor sockets are configured as shown in the figure below.

Sensor Socket	Sensor probes allowed for each sensor socket	
	Parameter	Reference
A	Weather Station WS-3000 (anemometer + wind vane + pluviometer)	9256-P
B	Soil Moisture 1	9248-P, 9324-P, 9323-P
	Solar Radiation (PAR)	9251-P
	Ultraviolet Radiation	9257-P
C	Soil Moisture 3	9248-P, 9324-P, 9323-P
	Dendrometers	9252-P, 9253-P, 9254-P
D (digital bus)	Soil Temperature (Pt-1000)	9255-P
	Temperature + Humidity + Pressure	9370-P
	Luminosity (Luxes accuracy)	9325-P
	Ultrasound (distance measurement)	9246-P
E	Leaf Wetness	9249-P
	Soil Moisture 2	9248-P, 9324-P, 9323-P
F (digital bus)	Temperature + Humidity + Pressure	9370-P
	Luminosity (Luxes accuracy)	9325-P
	Ultrasound (distance measurement)	9246-P

Figure: Sensor sockets configuration for Smart Agriculture PRO model

* Ask Libelium [Sales Department](#) for more information.

Note: For more technical information about each sensor probe go to the [Development section](#) on the Libelium website.

21.7. Ambient Control

This model is designed to monitor the main environment parameters easily. Only three sensor probes are allowed for this model, as shown in next table.



Figure: Ambient Control Waspote Plug & Sense! model

Sensor sockets are configured as it is shown in figure below.

Sensor Socket	Sensor probes allowed for each sensor socket	
	Parameter	Reference
A	Temperature + Humidity + Pressure	9370-P
B	Luminosity (LDR)	9205-P
C	Luminosity (Luxes accuracy)	9325-P
D, E and F	Not used	-

Figure: Sensor sockets configuration for Ambient Control model

As we see in the figure below, thanks to the directional probe, the Luminosity (Luxes accuracy) sensor probe may be placed in different positions. The sensor can be focused directly to the light source we want to measure.



Figure: Configurations of the Luminosity sensor probe (luxes accuracy)

Note: For more technical information about each sensor probe go to the [Development section](#) on the Libelium website.

21.8. Smart Cities PRO

The main applications for this Waspote Plug & Sense! model are noise maps (monitor in real time the acoustic levels in the streets of a city), air quality, waste management, smart lighting, etc. Refer to [Libelium website](#) for more information.



Figure: Smart Cities PRO Waspote Plug & Sense! model

Sensor sockets are configured as shown in the figure below.

Sensor Socket	Sensor probes allowed for each sensor socket	
	Parameter	Reference
A	Noise level sensor	NLS
	Temperature + Humidity + Pressure	9370-P
	Luminosity (Luxes accuracy)	9325-P
	Ultrasound (distance measurement)	9246-P
B, C and F	Carbon Monoxide (CO) for high concentrations [Calibrated]	9371-P
	Carbon Monoxide (CO) for low concentrations [Calibrated]	9371-LC-P
	Carbon Dioxide (CO ₂) [Calibrated]	9372-P
	Oxygen (O ₂) [Calibrated]	9373-P
	Ozone (O ₃) [Calibrated]	9374-P
	Nitric Oxide (NO) for low concentrations [Calibrated]	9375-LC-P
	Nitric Dioxide (NO ₂) high accuracy [Calibrated]	9376-HA-P
	Sulfur Dioxide (SO ₂) high accuracy [Calibrated]	9377-HA-P
	Ammonia (NH ₃) for low concentrations [Calibrated]	9378-LC-P
	Ammonia (NH ₃) for high concentrations [Calibrated]	9378-HC-P
	Methane (CH ₄) and Combustible Gas [Calibrated]	9379-P
	Hydrogen (H ₂) [Calibrated]	9380-P
	Hydrogen Sulfide (H ₂ S) [Calibrated]	9381-P
	Hydrogen Chloride (HCl) [Calibrated]	9382-P
	Hydrogen Cyanide (HCN) [Calibrated]	9383-P
	Phosphine (PH ₃) [Calibrated]	9384-P
	Ethylene (ETO) [Calibrated]	9385-P
	Chlorine (Cl ₂) [Calibrated]	9386-P
	Temperature + Humidity + Pressure	9370-P
	Luminosity (Luxes accuracy)	9325-P
Ultrasound (distance measurement)	9246-P	
D	Particle Matter (PM1 / PM2.5 / PM10) - Dust	9387-P
E	Temperature + Humidity + Pressure	9370-P
	Luminosity (Luxes accuracy)	9325-P
	Ultrasound (distance measurement)	9246-P

Figure: Sensor sockets configuration for Smart Cities PRO model

Note: For more technical information about each sensor probe go to the [Development section](#) in Libelium website.

Calibrated gas sensors are manufactured once the order has been placed to ensure maximum durability of the calibration feature. The manufacturing process and delivery may take from 4 to 6 weeks. The lifetime of calibrated gas sensors is 6 months working at maximum accuracy. We strongly encourage our customers to buy extra gas sensors to replace the original ones after that time to ensure maximum accuracy and performance.

21.9. Radiation Control

The main application for this Wasmote Plug & Sense! configuration is to measure radiation levels using a Geiger sensor. For this model, the Geiger tube is already included inside Wasmote, so the user does not have to connect any sensor probe to the enclosure. The rest of the other sensor sockets are not used.



Figure: Radiation Control Wasmote Plug & Sense! model

Sensor sockets are not used for this model.

Note: For more technical information about each sensor probe go to the [Development section](#) on the Libelium website.

21.10. 4-20 mA Current Loop

The applications for this Plug & Sense! model are focused on adding wireless connectivity to 4-20 mA devices and connecting them to the Cloud.



Figure: 4-20 mA Current Loop Waspote Plug & Sense! model

Sensor sockets are configured as shown in the figure below.

Sensor Socket	Sensor probes allowed for each sensor socket	
	Board channel	Reference
A	Channel 1 (type 2 and type 3)	9270-P, DB9-P
B	Channel 2 (type 2 and type 3)	9270-P, DB9-P
C	Channel 3 (type 2 and type 3)	9270-P, DB9-P
D	Channel 4 (type 4)	9270-P, DB9-P

Figure: Sensor sockets configuration for 4-20 mA Current Loop model

Note: For more technical information about each sensor probe go to the [Development section](#) on the Libelium website.

22. Programming

Waspote Plug & Sense! can be programmed using Libelium's Integrated Development Environment (IDE).

For further details on how to install the Waspote IDE and how to compile and upload your first programs, we advise to read the "Waspote IDE: User Guide". This guide contains step-by-step indications to get started; it can be found on the Plug & Sense! Development section:

www.libelium.com/development/plug-sense/sdk_applications/

22.1. Real time Clock - RTC

Waspote Plug & Sense! has a built-in Real Time Clock – RTC, which keeps it informed of the time. This allows to program and perform time-related actions such as:

"Sleep for 1h 20 min and 15sec, then wake up and perform the following action.."

Or even programs to perform actions at absolute intervals, e.g.:

"Wake on the 5th of each month at 00:20 and perform the following action.."

All RTC programming and control is done through the I2C bus.

Alarms:

Alarms can be programmed in the RTC specifying day/hour/minute/second. That allows total control about when the mote wakes up to capture sensor values and perform actions programmed on it. This allows Waspote Plug & Sense! to be in the saving energy mode (Deep Sleep) and makes it wake up just at the required moment.

As well as relative alarms, periodic alarms can be programmed by giving a time measurement, so that the node reprograms its alarm automatically each time one event is triggered.

Waspote Plug & Sense! can keep the RTC time correctly even if the on/off button is switched to off position.

RTC module has an internal compensation mechanism for the oscillation variations produced in the quartz crystal by changes in temperature (Temperature Compensated Crystal Oscillator – TCXO).

The RTC is responsible for waking the node up from energy saving mode called Deep Sleep. In addition, it controls when it has to wake up the node and perform a particular action.

All information about their programming and operation can be found in the [RTC Programming Guide](#).

All the documentation is located in the [Development section](#) in the Libelium website.

22.2. Interruptions

Interruptions are signals received by the microcontroller which indicate it must stop the task it is doing to handle an event that has just happened. Interruption control frees the microcontroller from having to control sensors all the time. It also makes the sensors warn Waspote Plug & Sense! when a determined value (threshold) is reached.

Waspote Plug & Sense! is designed to work with two types of interruptions: Synchronous and asynchronous:

- **Synchronous interruptions:** They are scheduled by timers. They allow to program when we want them to be triggered. There are two types of timer alarms: periodic and relative.
 - **Periodic alarms** are those to which we specify a particular moment in the future, for example: "Alarm programmed for every fourth day of the month at 00:01 and 11 seconds". They are controlled by the RTC.
 - **Relative alarms** are programmed taking into account the current moment, eg: "Alarm programmed for 5 minutes and 10 seconds". They are controlled through the RTC and the microcontroller's internal Watchdog.
- **Asynchronous Interruptions:** These are not scheduled, so it is not known when they will be triggered. Types:
 - **Sensors:** The sensor boards can be programmed so that an alarm is triggered when a sensor reaches a certain threshold.
 - **Accelerometer:** The accelerometer can be programmed so that certain events such (as a fall or change of direction) generate an interruption.

All interruptions, both synchronous and asynchronous can **wake** Waspote Plug & Sense! up from the **Sleep** and the **Deep Sleep** modes.

All information about the programming and operation of interruptions can be found in the **Interruption Programming Guide**.

22.3. Watchdog

The ATmega1281 microcontroller inside the Waspote Plug & Sense! has an internal Enhanced Watchdog Time – WDT. The WDT *precisely* counts the clock cycles generated by a **128 kHz oscillator**. The WDT generates an interruption signal when the counter reaches the set value. This interruption signal can be used to wake the microcontroller from the **Sleep** mode or to generate an internal alarm when it is running in on mode, which is very useful when developing programs with timed interruptions.

The WDT allows the microcontroller to wake up from a low consumption Sleep mode by generating an interruption. For this reason, this clock is used as a time-based alarm associated with the microcontroller's Sleep mode. This allows very precise control of small time intervals: **16 ms, 32 ms, 64 ms, 128 ms, 256 ms, 500 ms, 1 s, 2 s, 4 s, 8 s**. For intervals over 8 s (Deep Sleep mode), the RTC is used and not the microcontroller.

All information about their programming and operation can be found in the [Interrupt Programming Guide](#).

All the documentation is located in the Development section in the Libelium website.

22.3.1. RTC Watchdog for resetting Waspote

One of the alarms of the RTC (Alarm 2) is connected to a Watchdog reset circuit that is able to reset the microcontroller of Waspote Plug & Sense! when the alarm is generated. This Watchdog has been implemented for resetting Waspote Plug & Sense! if it gets stuck. That periodical reset avoids erratic behaviour. This is highly recommended for applications that need to be very robust and can never stop working. The use of the Watchdog feature ensures us that our Waspote will never stop working.

The Watchdog feature requires the physical watchdog switch to be put in "enable" position (default state in Waspote Plug & Sense! Devices).

All information about the RTC programming and operation can be found in the [RTC Programming Guide](#).

All the documentation is located in the Development section in the Libelium website.

23. Programming Cloud Service

The Programming Cloud Service is an intuitive graphic interface which creates code automatically. The user just needs to fill a web form to obtain binaries for Plug & Sense!. Advanced programming options are available, depending on the license selected.

Features:

- No more programming, just configure a web form and the PCS will create the binary
- Always up-to-date: code is compiled on the Cloud, with the latest libraries
- Advanced options: Water and Ions calibration, Watchdog, critical battery warning, GPS, Industrial Protocols, HTTPS, encryption (at both payload and link levels), etc
- Template management
- New devices are added easily (bulk or individual activation codes)
- Simple devices management: list, order, search or filter
- Share your devices with others
- Three license types: Basic, PRO and Elite
- Easy licenses management
- Summary reports
- Just program any standard Plug & Sense! in minutes!

Check how easy it is to handle the Programming Cloud Service at:

<https://cloud.libelium.com/>

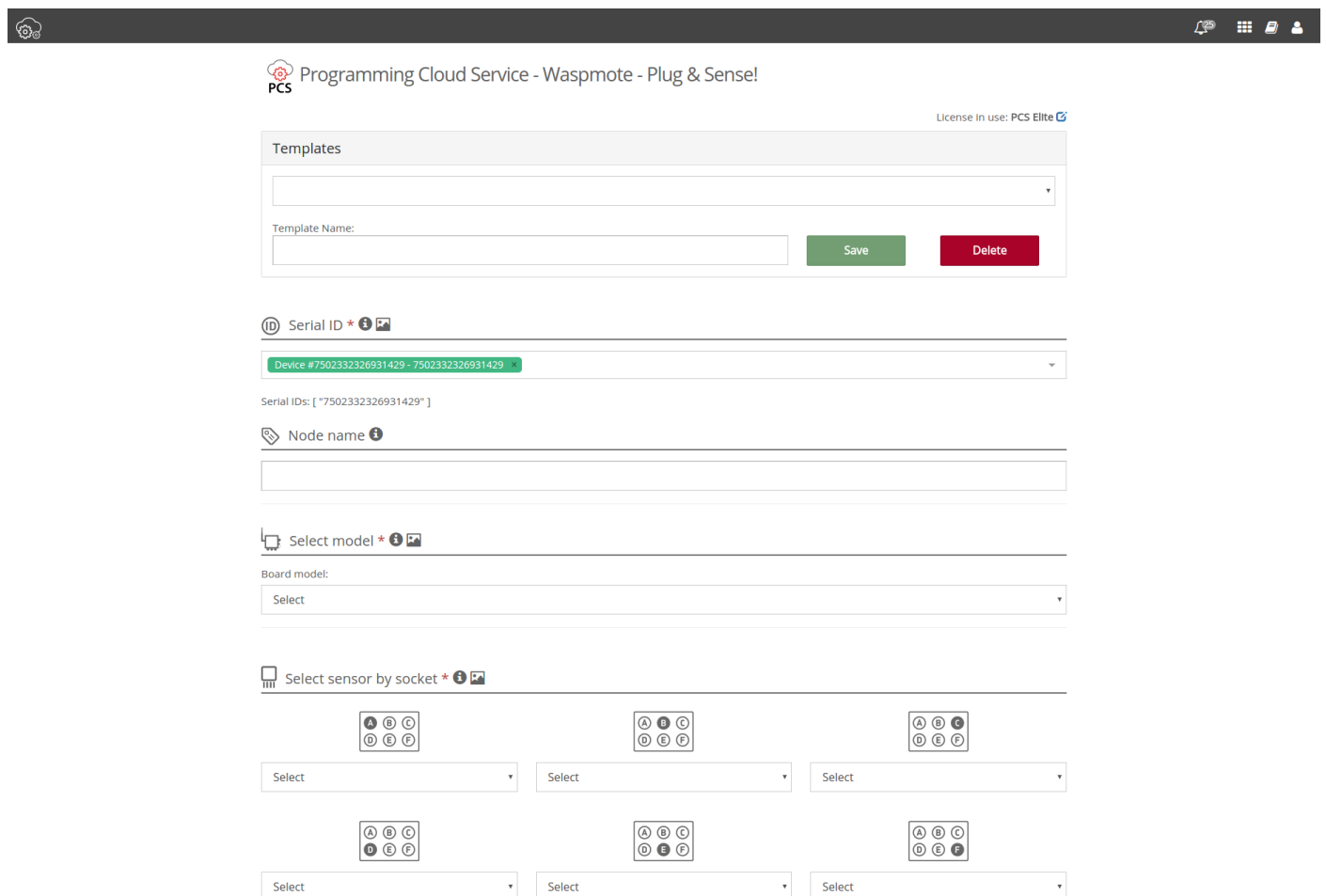

Figure: Programming Cloud Service

24. Uploading code

Using the USB connector, a new code can be uploaded to Wasp mote without opening Wasp mote Plug & Sense!. Just connect one side of the USB cable to this connector, removing protection cap if necessary and connect the other side to a PC. Remember that Wasp mote must be on to allow uploading a new code. Next steps describe this process in detail.

Step 1: Open the USB connector

Remove the protection cap of the USB connector.



Figure: Removing the USB cap

* In the case you have a Plug & Sense! with a 4G module, insert your nano-SIM card in the External SIM/USB socket with care.



Figure: Inserting a SIM card with care in the External SIM/USB socket

Step 2: Connect the USB cable to Wasp mote Plug & Sense!

Connect one end of the provided male-to-male USB cable to the USB connector. For models with 4G module, a micro-USB is supplied.



Figure: Connecting the USB cable to Wasp mote Plug & Sense!

Step 3: Connect the USB cable to PC

Connect the other end of the USB cable to your PC.

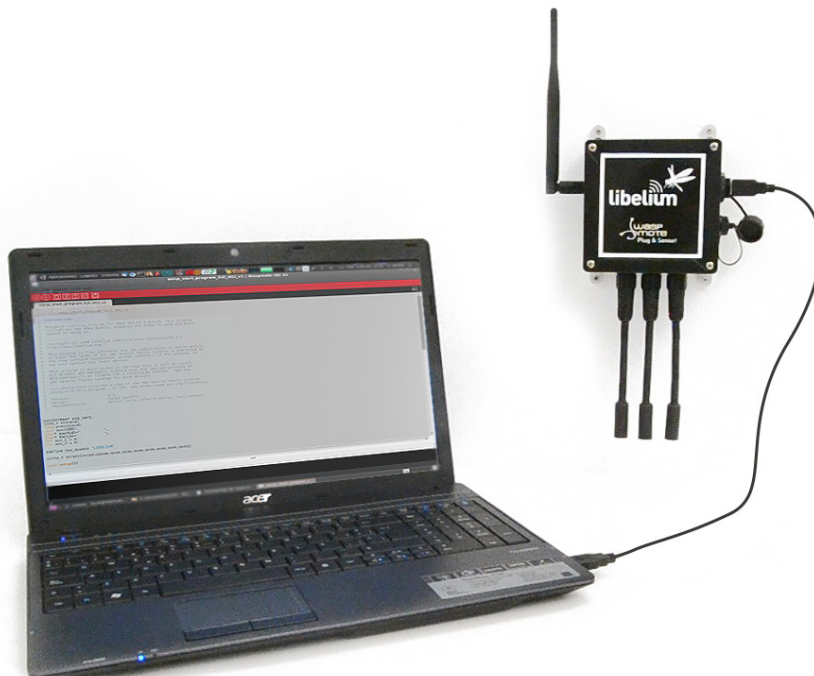

Figure: Connecting the node to a PC

Step 4: Turn on Wasp mote Plug & Sense!

Be sure you have turned on the node by pressing on/off button.



Figure: Turning on Wasp mote

Step 5: Open Wasp mote IDE

Now run Wasp mote IDE on your PC. If you do not have Wasp mote IDE already installed in your PC, then go to the Development section of Libelium website to download the latest version; there is a dedicated guide to help in the process: "Wasp mote IDE: User Guide".

If it is the first time you plug a Wasp mote Plug & Sense! on your PC and you are unable to see the proper USB port, maybe you should install the latest FTDI drivers: <http://www.ftdichip.com/Drivers/D2XX.htm>

Moreover, if you have troubles installing FTDI drivers and your computer is unable to recognize Wasp mote, please follow the installation guide for your operating system on your next link: <http://www.ftdichip.com/Support/Documents/InstallGuides.htm>

Step 6: Select the corresponding code

Go to the examples menu and open your desired example. Then modify it according to your application and save the sketch with the save button. For instance with the name “Wasmote_Plug_Sense_test_code”, and check the IDE message “Done Saving”.

Save the sketch (Wasmote IDE has a button for that), for example with the name “Wasmote_Plug_Sense_test_code”, and check the IDE message “Done Saving”.

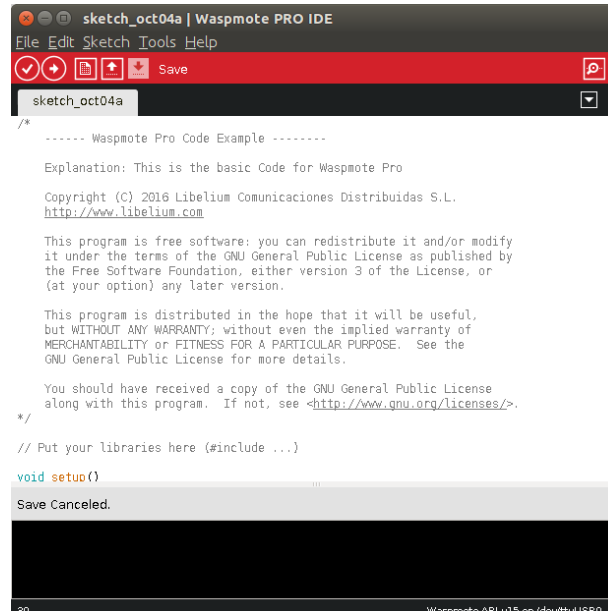

Figure: Preparing code for Wasmote Plug & Sense!

Step 7: Select the corresponding API

Select the latest API version going to tools/board. There can be only one API in each installed IDE. Please read the “IDE: User Manual” for more details.



Figure: Selecting API

Please notice that Wasmote “OEM” and Plug & Sense! share the same API and IDE. The same software system is valid for both platforms.

Step 8: Select the USB port

Select the corresponding serial port by going to tools/serial port. If you are unable to see the proper USB port maybe you should install the latest FTDI drivers.

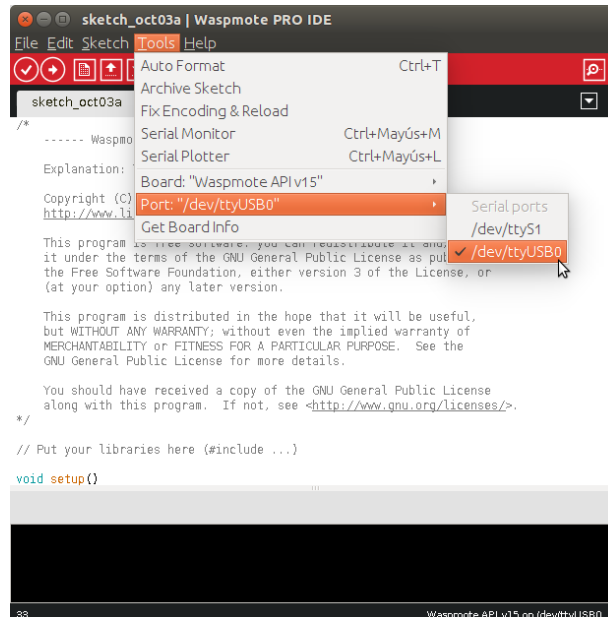

Figure: Selecting the USB port for WaspMote Plug & Sense!

Note: the name of the USB ports depends on the OS and the particular PC you have. The best way to find the USB where WaspMote is connected is trial & error.

Step 9: Compile the code

Compile the code (the IDE has a button for that), and check there are no errors or warnings. The IDE should say "Done Compiling".

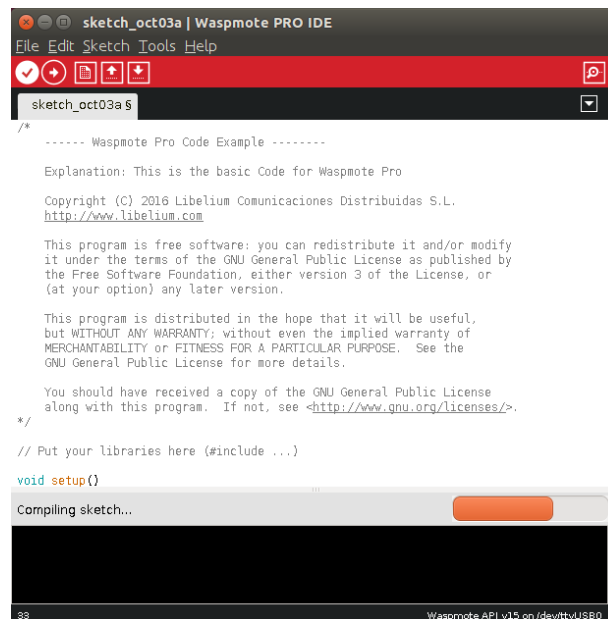

Figure: Compiling a code for WaspMote Plug & Sense!

Step 10: Upload the code

Now, press the upload button and see messages coming out from IDE. During a while you will see message “uploading to I/O board”.

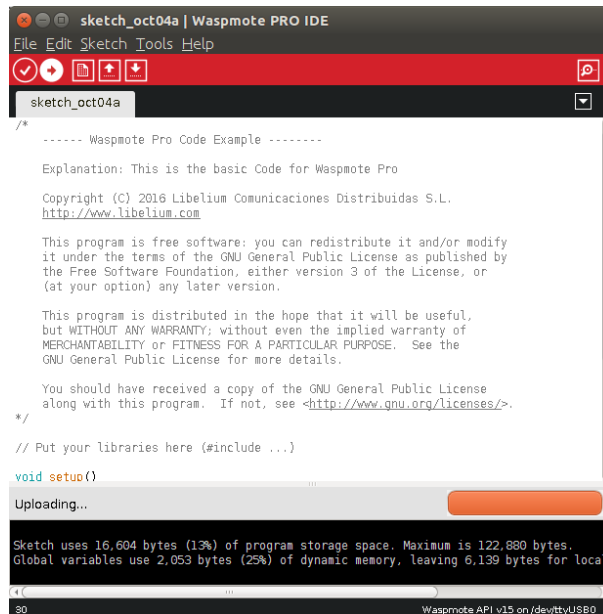

Figure: Uploading a code for WaspMote Plug & Sense!

Wait a few seconds until the process ends and check there are no error messages, just “Done uploading” message.

Step 11: Open the Serial Monitor

If uploading processes are successfully completed, open Serial Monitor to see the output of the uploaded code.

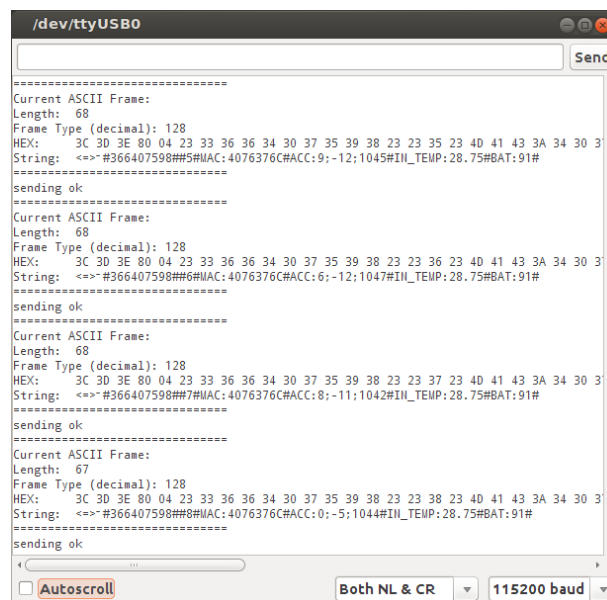

Figure: Opening WaspMote IDE serial monitor

When uploading processes are finished successfully, do not forget to screw the protection cap of USB connector to avoid its damage.

Never connect a USB which exceed maximum rating of the USB standard. WaspMote can be damaged and warranty voided.

25. Over the air programming – OTA

25.1. Overview

The concept of Wireless Programming or commonly know as Programming Over the Air (OTA) has been used in the past years overall for the reprogramming of mobile devices such as cell phones. However, with the new concepts of Wireless Sensor Networks and the Internet of Things where the networks consist of hundreds or thousands of nodes OTA is taken to a new direction.

Libelium provides an OTA method based on FTP transmissions to be used with 4G and WiFi modules.

25.2. OTA with 4G/WiFi modules via FTP

It is possible to update the Waspote's program using Over The Air Programming and the following modules: 4G or WiFi module.

The Waspote reprogramming is done using an FTP server and an FTP client which is Waspote itself. The FTP server can be configured by Meshlium. Otherwise, the user will have to setup an FTP server.

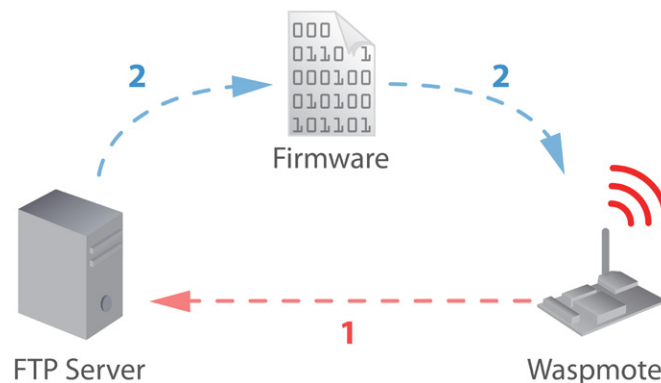

Figure: OTA via FTP protocol

There are two basic steps involved in OTA procedure:

- **Step 1:** Waspote requests a special text file which gives information about the program to update: program name, version, size, etc.
- **Step 2:** If the information given is correct, Waspote queries the FTP server for a new program binary file and it updates its flash memory in order to run the new program.



Figure: OTA steps via FTP protocol

25.2.1. Setting the FTP server configuration

The FTP server that Wasmote connects to needs a specific configuration so as to OTA work properly. There are two ways to set up the FTP server:

Extern user's FTP server: The user sets up an FTP server following the specific settings which are described within OTA Guide.

Meshlium FTP server: There is a specific plugin which allows the user to setup the FTP server automatically indicating the new binary to be downloaded.

26. Encryption libraries

The new Encryption Libraries are designed to add to the WaspMote sensor platform the capabilities necessary to protect the information gathered by the sensors. To do so **two cryptography layers** are defined:

- **Link Layer:** In the first one all the nodes of the network share a common **preshared key** which is used to encrypt the information using **AES 128**. This process is carried out by specific hardware integrated in the same 802.15.4/ZigBee radio, allowing the maximum efficiency of the sensor nodes energy consumption. This first security layer ensures no third party devices will be able to even connect to the network (access control).
- **Secure Web Server Connection:** The second security technique is carried out in Meshlium -the Gateway- where **HTTPS** and **SSH** connections are used to send the information to the Cloud server located on the Internet.

A third optional encryption layer allows each node to encrypt the information using the Public key of the Cloud server. Thus, the information will be kept confidentially all the way from the sensor device to the web or data base server on the Internet.

Transmission of sensor data

Information is encrypted in the application layer via software with **AES 256** using the key shared exclusively between the origin and the destination. Then the packet is encrypted again in the link layer via hardware with **AES 128** so that only trusted packets be forwarded, ensuring access control and improving the usage of resources of the network.

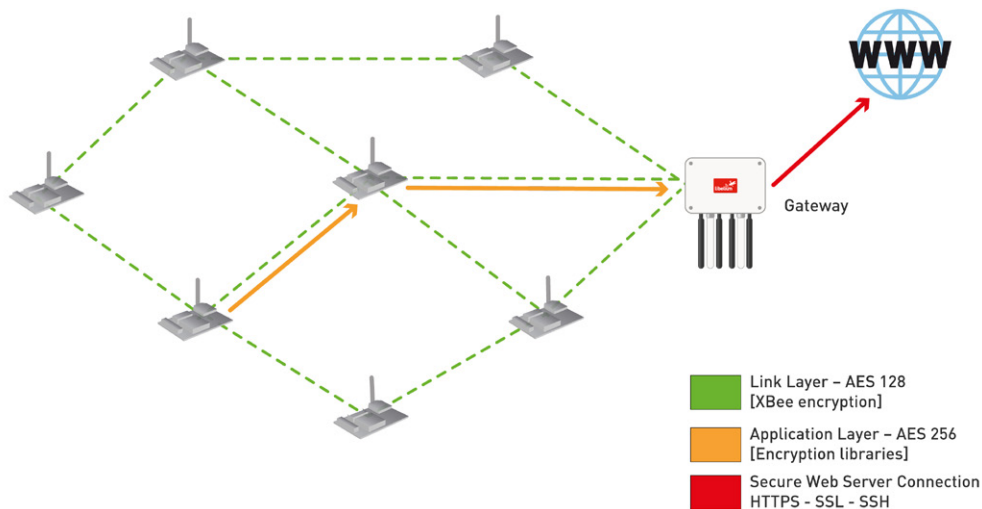

Figure: Communication diagram

Related API libraries:

- WaspAES.h, WaspAES.cpp
- WaspRSA.h, WaspRSA.cpp
- WaspHash.h, WaspHash.cpp

All information about their programming and operation can be found in the [Encryption Programming Guide](#).

All the documentation is located in the [Development section](#) in the Libelium website.

27. Interacting with Waspote

27.1. Receiving XBee frames with Waspote Gateway

27.1.1. Waspote Gateway

This device allows to collect data which flows through the sensor network into a **PC** or device with a standard USB port. Waspote Gateway will act as a **"data bridge or access point"** between the sensor network and the receiving equipment. This receiving equipment will be responsible for storing and using the data received depending on the specific needs of the application.



Figure: Waspote Gateway

The receiving equipment can be a PC with Linux, Windows or Mac-OS, or any device compatible with standard USB connectivity. The gateway offers a male **USB A** connector, so the receiving device has to have a female USB A connector.

Once the Gateway is correctly installed, a new communication serial port connecting directly to the XBee module's UART appears in the receiving equipment, which allows the XBee to communicate directly with the device, being able to both receive data packets from the sensor network as well as modify and/or consult the XBee's configuration parameters.

Another important function worth pointing out is the possibility of **updating or changing the XBee module's firmware**.

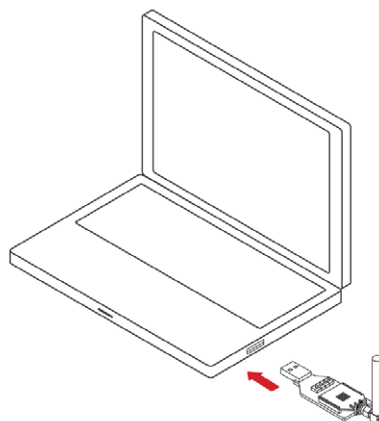

Figure: Waspote Gateway connected to a PC

LEDs

Four indicator LEDs are included in the Gateway:

- USB power LED: indicates that the board is powered through the USB port
- RX LED: indicates that the board is receiving data from the USB port
- TX LED: Indicates that the board is sending data to the USB port
- I/O 5 configurable LED: associate

The configurable LED connected to the XBee's I/O 5 pin can be configured either as the XBee's digital output or as the XBee's indicator of association to the sensor network.

Buttons

- Reset: allows the XBee module to be reset
- I/O - 0: button connected to the XBee's I/O pin 0
- I/O -1: button connected to the XBee's I/O pin 1
- RTS - I/O - 6: button connected to the XBee's I/O pin 6

All the buttons connect each one of its corresponding data lines with GND with when pressed. None of these have pull-up resistance so it may be necessary to activate any of the XBee's internal pull-up resistances depending on the required use.

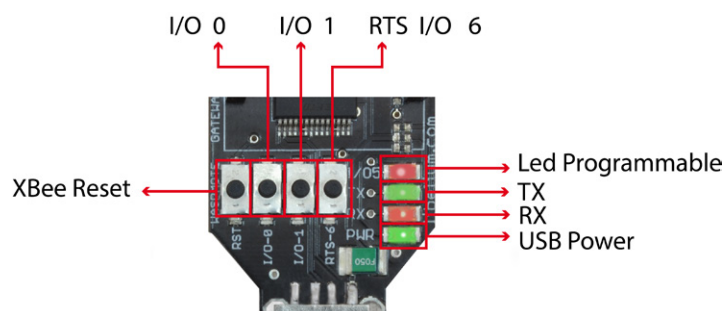

Figure: LEDs in Waspote Gateway

27.1.2. Linux receiver

When using Linux it is possible to use various applications to capture the input from the serial port. Libelium recommends to use the 'Cutecom' application.

Once the application is launched, the speed and the USB where Waspote has been connected must be configured.

The speed that must be selected is 115200 bps which is the standard speed set up for Waspote.

The USB where Waspote has been connected must be added the first time this application is run, adding USB0, USB1, etc (up to the USB number of each computer) according to where Waspote has been connected. For this, the 'Device' window must be modified so that if Waspote is connected to USB0, this window contains '/dev/ttyUSB0'.

Once these parameters are configured, capture is started by pressing the 'Open Device' button.

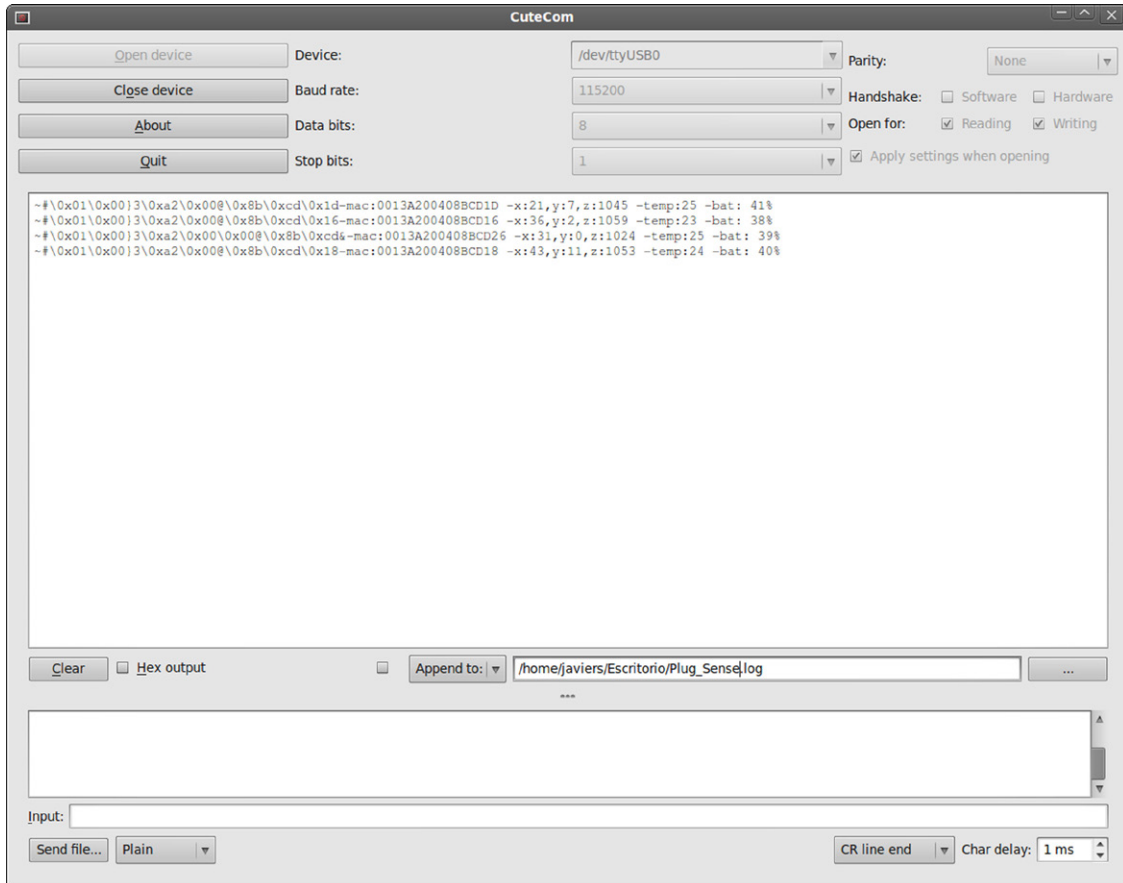

Figure: Cutedcom application capturing Waspote's output

Linux Sniffer

As well as using the terminal to see the sensor information, an application which allows this captured data to be dumped to a file or passed to another program to be used or checked has been developed.

File:
"sniffer.c"

Compilation on Linux:

```
gcc sniffer.c -o sniffer
```

Examples of use:

- Seeing received data: `./sniffer USB0`
- Dumping of received data to a file: `./sniffer USB0 >> data.txt`
- Passing received values to another program: `./sniffer USB0 | program`

Note: The speed used for the example is 19200 bps. The final speed will depend on the speed the XBee module has been configured with (default value 115200).

Code:

```
#include <stdio.h>
#include <string.h>
#include <unistd.h>
#include <fcntl.h>
#include <errno.h>
```

```
#include <stdlib.h>
#include <termios.h> /* Terminal control library (POSIX) */

#define MAX 100

main(int argc, char *argv[])
{
    int sd=3;
    char *serialPort="";

char *serialPort0 = "/dev/ttyS0";
char *serialPort1 = "/dev/ttyS1";
char *USBserialPort0 = "/dev/ttyUSB0";
char *USBserialPort1 = "/dev/ttyUSBS1";
char valor[MAX] = "";
char c;
char *val;
struct termios opciones;
int num;
char *s0 = "S0";
char *s1 = "S1";
char *u0 = "USB0";
char *u1 = "USB1";

    if(argc!=2)
    {
        fprintf(stderr,"Usage: %s [port]\nValid ports: (S0, S1, USB0, USB1)\n",argv[0], serial-
Port);
        exit(0);
    }

    if (!strcmp(argv[1], s0))
    {
        fprintf(stderr,"ttyS0 chosen\n...");
        serialPort = serialPort0;
    }
    if (!strcmp(argv[1], s1))
    {
        fprintf(stderr,"ttyS1 chosen\n...");
        serialPort = serialPort1;
    }
    if (!strcmp(argv[1], u0))
    {
        fprintf(stderr,"ttyUSB0 chosen\n...");
        serialPort = USBserialPort0;
    }
    if (!strcmp(argv[1], u1))
    {
        fprintf(stderr,"ttyUSB1 chosen\n...");
        serialPort=USBserialPort1;
    }
    if (!strcmp(serialPort, ""))
    {
        fprintf(stderr, "Choose a valid port (S0, S1, USB0, USB1)\n", serialPort);
        exit(0);
    }

    if ((sd = open(serialPort, O_RDWR | O_NOCTTY | O_NDELAY)) == -1)
    {
        fprintf(stderr,"Unable to open the serial port %s - \n", serialPort);
        exit(-1);
    }
}
```

```
else
{
  if (!sd)
  {
    sd = open(serialPort, O_RDWR | O_NOCTTY | O_NDELAY);
  }
  //fprintf(stderr,"Serial Port open at: %i\n", sd);
  fcntl(sd, F_SETFL, 0);
}
tcgetattr(sd, &opciones);
cfsetispeed(&opciones, B19200);
cfsetospeed(&opciones, B19200);
opciones.c_cflag |= (CLOCAL | CREAD);
/*No parity*/

opciones.c_cflag &= ~PARENB;
opciones.c_cflag &= ~CSTOPB;
opciones.c_cflag &= ~CSIZE;
opciones.c_cflag |= CS8;
/*raw input:
 * making the applycation ready to receive*/
opciones.c_lflag &= ~(ICANON | ECHO | ECHOE | ISIG);
/*Ignore parity errors*/
opciones.c_iflag |= ~(INPCK | ISTRIP | PARMRK);
opciones.c_iflag |= IGNPAR;
opciones.c_iflag &= ~(IXON | IXOFF | IXANY | IGNCR | IGNBRK);
opciones.c_iflag |= BRKINT;
/*raw output
 * making the applycation ready to transmit*/
opciones.c_oflag &= ~OPOST;
/*aply*/
tcsetattr(sd, TCSANOW, &opciones);
int j = 0;
while(1)
{
  read(sd, &c, 1);
  valor[j] = c;
  j++;

  // We start filling the string until the end of line char arrives
  // or we reach the end of the string. Then we write it on the screen.

  if ((c=='\n') || (j==(MAX-1)))
  {
    int x;
    for (x=0; x<j; x++)
    {
      write(2, &valor[x], 1);
      valor[x] = '\0';
    }
    j = 0;
  }
}
close(sd);
}
```

The code can be downloaded from: <http://www.libelium.com/development/waspote>

27.1.3. Windows receiver

If Windows is used, the application 'Hyperterminal' can be used to capture the output of the serial port.

This application can be found installed by default in 'Start/Programs/Accessories/Communication', but if it is not available it can be downloaded from: <http://hyperterminal-private-edition-htpe.en.softonic.com/>

Once this application is launched the connection must be configured. The first step is to give it a name:



Figure: Step 1 of establishing connection

The next step is to specify the port on which Waspote has been connected, in this case the system recognizes it as 'COM9', (this will vary on each computer):

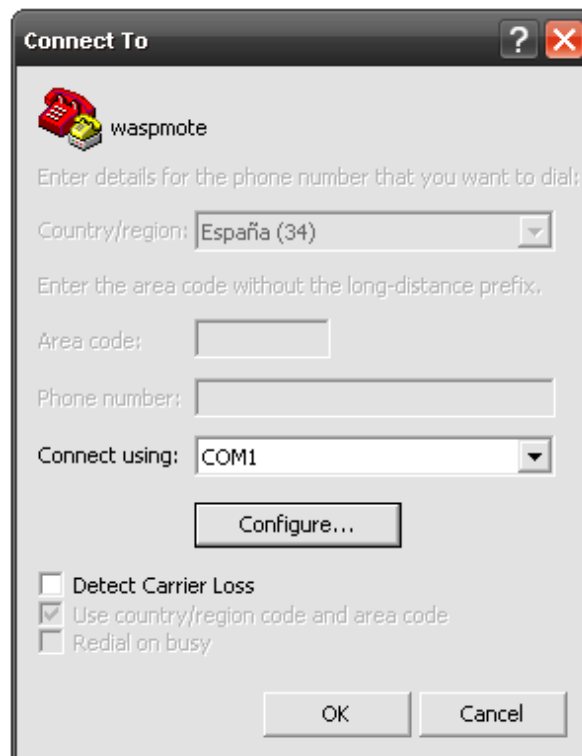

Figure: Step 2 of establishing connection

The next step is to specify the speed and configuration parameters:

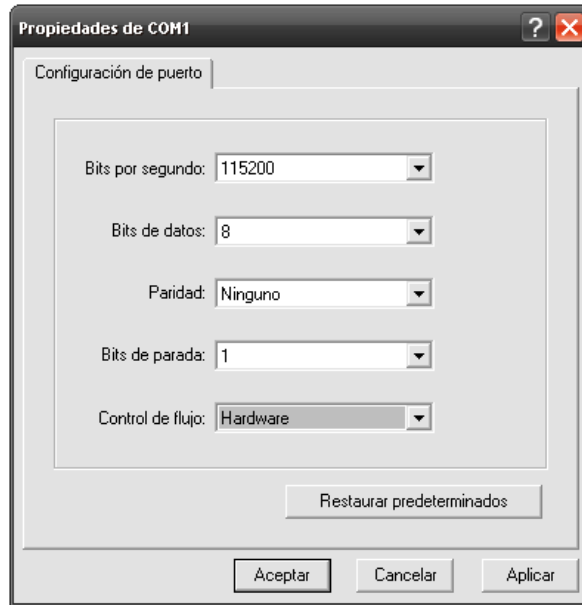

Figure: Step 3 of establishing connection

Once these steps have been performed connection with Waspote has been established, and listening to the serial port begins.

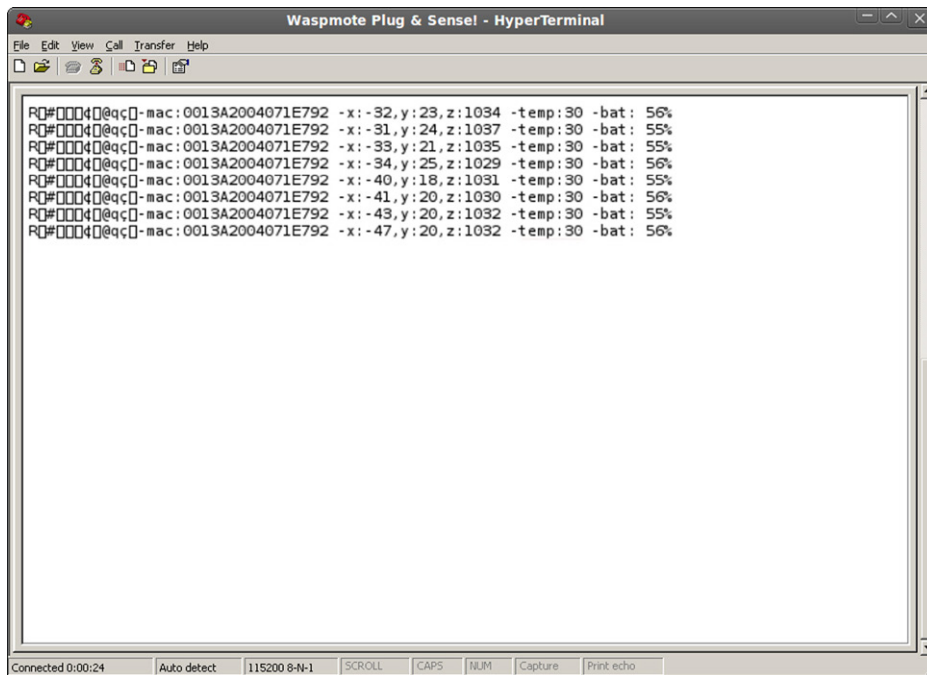

Figure: HyperTerminal application capturing Waspote's output.

27.1.4. Mac-OS receiver

If Mac OS X is used (version later than 10.3.9) the application 'ZTERM' can be used to capture the serial port output. This application can be downloaded from: <http://homepage.mac.com/dalverson/zterm/>

This application is configured automatically, establishing the USB on which Waspote has been connected and the speed.

The following image shows this application capturing Waspote's output, while the example code 'Waspote Accelerator Basic Example' is run.

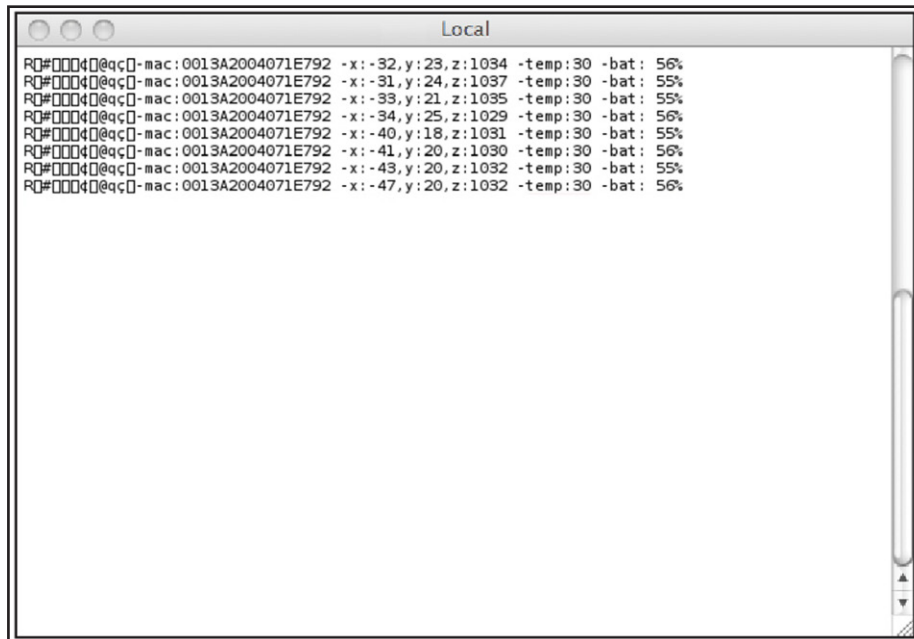

```
Local
RQ#00040@qc-mac:0013A2004071E792 -x: -32,y:23,z:1034 -temp:30 -bat: 56%
RQ#00040@qc-mac:0013A2004071E792 -x: -31,y:24,z:1037 -temp:30 -bat: 55%
RQ#00040@qc-mac:0013A2004071E792 -x: -33,y:21,z:1035 -temp:30 -bat: 55%
RQ#00040@qc-mac:0013A2004071E792 -x: -34,y:25,z:1029 -temp:30 -bat: 56%
RQ#00040@qc-mac:0013A2004071E792 -x: -40,y:18,z:1031 -temp:30 -bat: 55%
RQ#00040@qc-mac:0013A2004071E792 -x: -41,y:20,z:1030 -temp:30 -bat: 56%
RQ#00040@qc-mac:0013A2004071E792 -x: -43,y:20,z:1032 -temp:30 -bat: 55%
RQ#00040@qc-mac:0013A2004071E792 -x: -47,y:20,z:1032 -temp:30 -bat: 56%
```

Figure: Waspote's output capture

28. Meshlium - The IoT Gateway



Figure: Meshlium device

The sensor data gathered by the Waspote Plug & Sense! nodes is sent to the Cloud by Meshlium, the IoT gateway router specially designed to connect Waspote sensor networks to the Internet via Ethernet and 4G/3G/2G interfaces.

Meshlium can work as:

- an RF (XBee) to Ethernet router for Waspote nodes*
- an RF (XBee) to 4G/3G/GPRS/GSM router for Waspote nodes*
- a WiFi Access Point
- a WiFi to 4G/3G/GPRS/GSM router
- a GPS - 4G/3G/GPRS/GSM real-time tracker
- a smartphone scanner (detects iPhone and Android devices)

28.1. Meshlium Storage Options

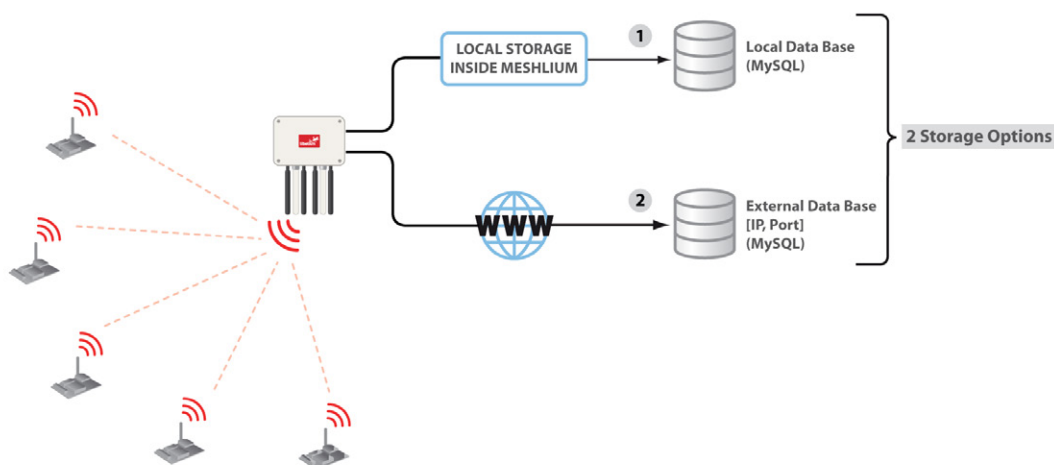

Figure: Meshlium storage options

- Local data base
- External data base

28.2. Meshlium connection options

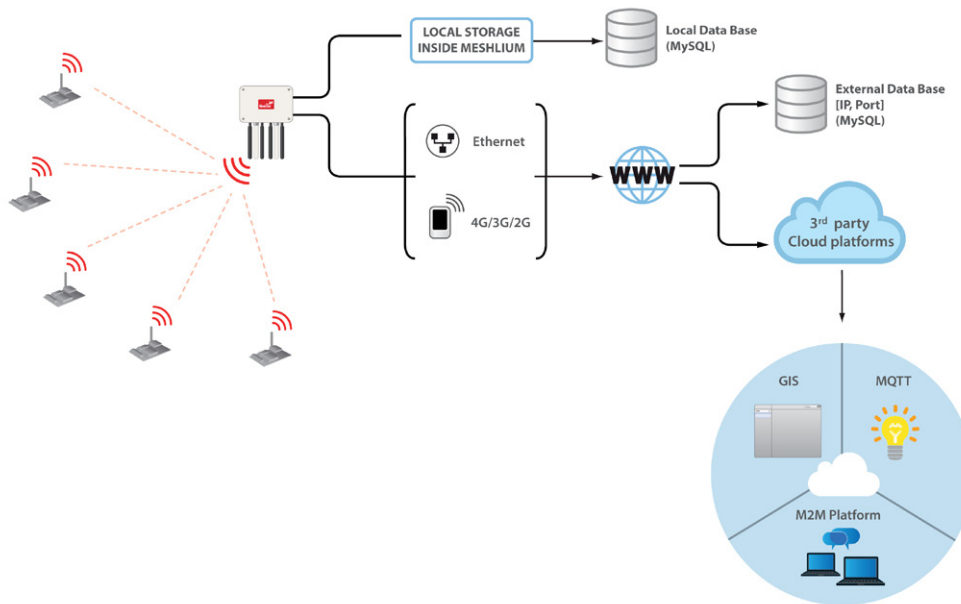

Figure: Meshlium connection options

- XBee / 4G / 3G / 2G / WiFi → Ethernet
- XBee / 4G / 3G / 2G / WiFi → 4G / 3G / 2G

All the networking options can be controlled from the **Manager System**, a web interface which comes with Meshlium. It allows to control all the interfaces and system options in a secure, easy and quick way.



Figure: Meshlium Manager System

All information about Meshlium can be found in the [Meshlium Technical Guide](#).

All the Meshlium documentation is located in the [Development section](#) in the Libelium website.

28.3. Meshlium Visualizer

Meshlium Visualizer is a plugin which plots graphs and maps with the data stored in the database. It can also export data in common formats. Meshlium Visualizer is a special software feature only available in the Meshlium units included in the IoT Vertical Kits (Smart Cities IoT Vertical Kit, Smart Water IoT Vertical Kit, etc).

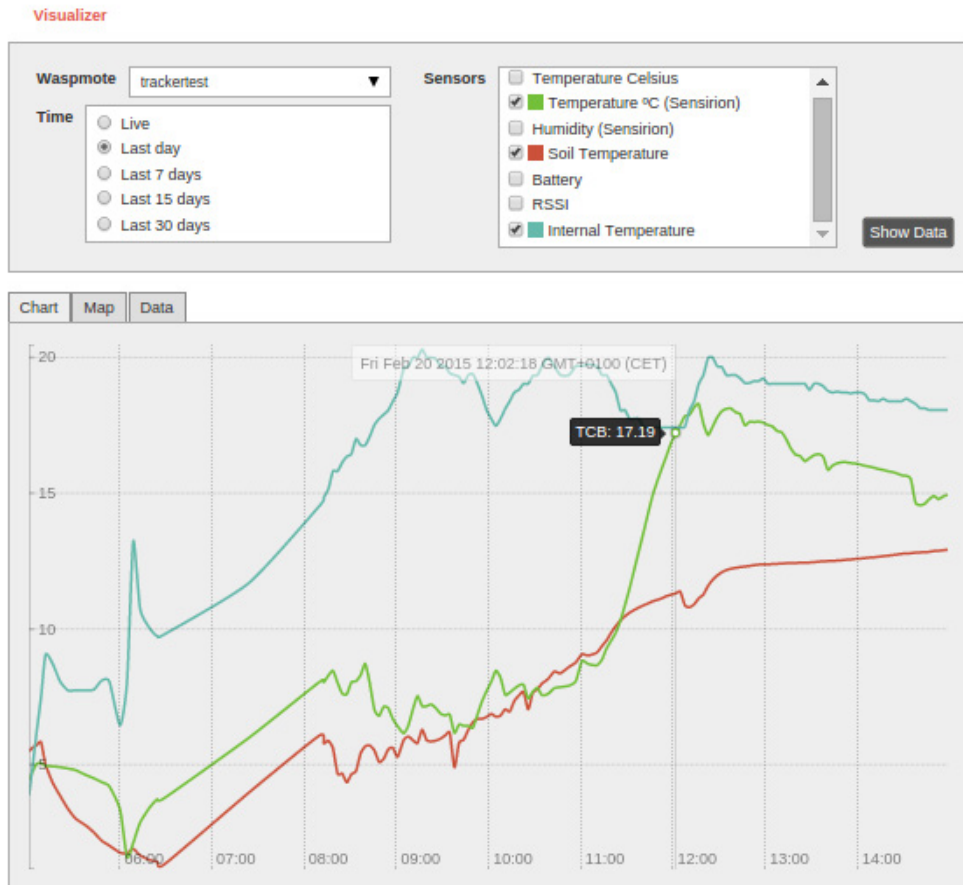

Figure: Meshlium visualizer

28.4. Cloud Connectors

Meshlium allows developers to connect easily with third party cloud servers such as Amazon, IBM, Telefónica, ESRI, Thingworks, etc. Just select the desired plugin in the Manager System and add the account info to synchronize the internal data base of Meshlium with the desired platform.



For more info about Meshlium go to:
<http://www.libelium.com/products/meshlium/>

29. Installation

The right behavior of Waspote Plug & Sense! depends on a reliable installation. Libelium provides the necessary accessories to make it easy, like cable ties, mounting feet and other accessories.

Wherever Waspote Plug & Sense! is placed, please be sure you tight it firmly and the enclosure is not affected by wind, vibrations and other environmental conditions. Libelium does not take responsibility of damages to third parts caused by a bad installation. Moreover, it is recommended to power off Waspote Plug & Sense! during its installation.

29.1. Parts

Mounting feet

Libelium provides four mounting feet accessories to allow easy fixing Waspote Plug & Sense! to walls, etc. Mounting feet come already fixed to the enclosure using a screw, as shown in figures below.



Figure: Mounting feet accessory

Cable ties

Another provided accessories are PVC coated stainless steel cable ties. Dimensions of these ties are 1 meter length and 5 millimeters width.



Figure: Metal cable ties



Figure: Using metal cable ties

Solar panel bracket

The solar panel brackets are used to achieve 45 degrees of inclination when a solar panel is used.

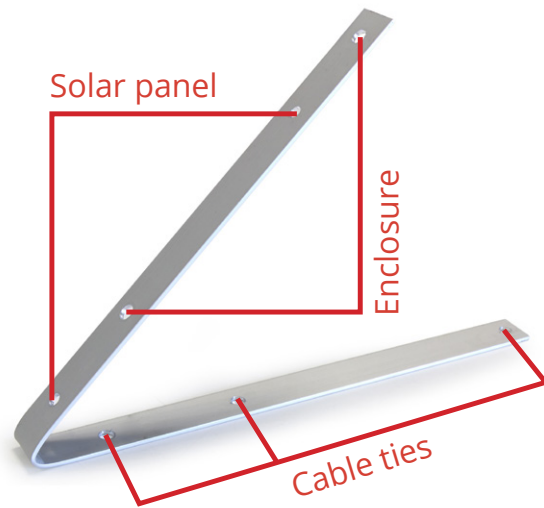

Figure: Solar panel bracket

Wasmote Plug & Sense! accessories can vary depending on which configuration is acquired. See text and figure below to know which accessories are provided with each of the options.

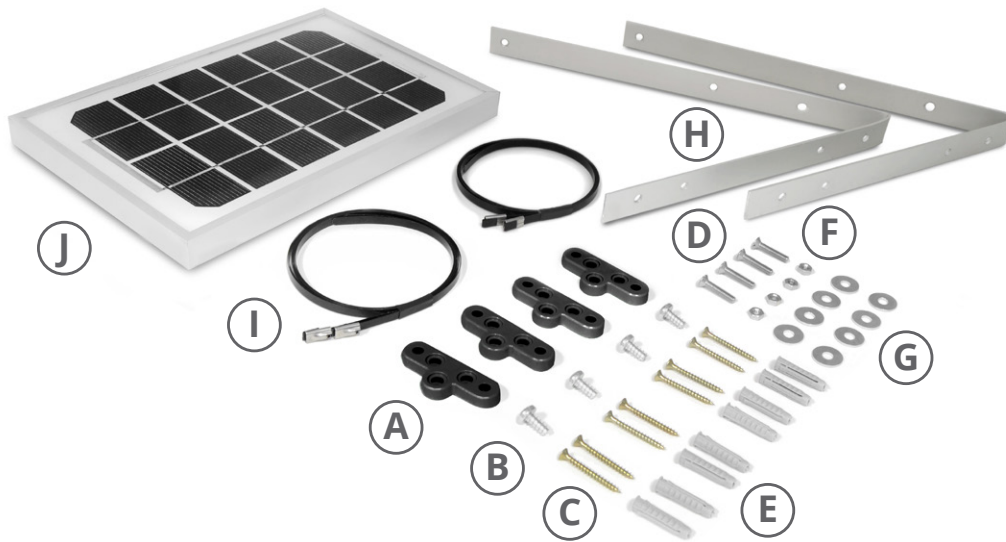

Figure: Wasmote Plug & Sense! accessories

1- Basic

This configuration includes 4 mounting feet (A), 4 screws type 1 (B), 4 screws type 2 (C), 4 wall plugs (E) and 2 cable ties (I). No solar panel is included.

2- With external solar panel

This configuration includes 4 mounting feet (A), 4 screws type 1 (B), 8 screws type 2 (C), 8 wall plugs (E), 4 screws type 3 (D), 4 nuts (F), 8 washers (G), 2 solar panel brackets (H), 4 cable ties (I) and 1 external solar panel (J).

29.2. Street Light installation

The node can be fixed to a street light using the PVC coated stainless steel cable ties provided by Libelium. Always be sure that the enclosure is firmly tied and environmental elements (like wind) do not modify its position. Next pictures show examples of typical installation processes using the external solar panel in combination with the provided accessories.

29.2.1. External solar panel

Step 1: Prepare the cable ties

Introduce cable ties through external holes of the mounting feet.

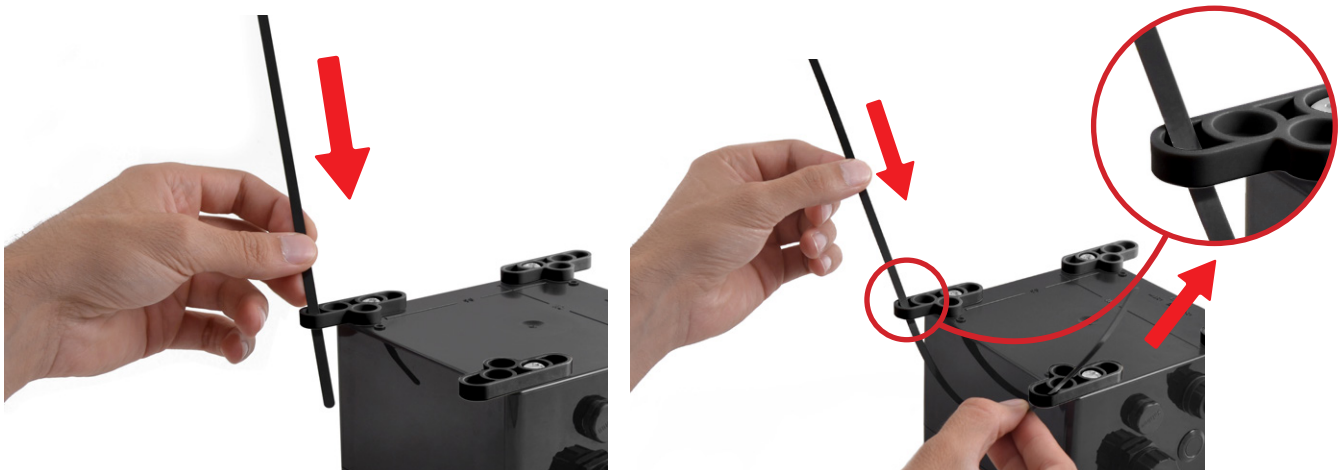

Figure: Preparing metal cable ties

Step 2: Secure the solar panel bracket to the external solar panel

Use provided screws to secure the solar panel bracket to the external solar panel. Be sure you place screws in the right bracket holes, as shown in the figure below.



Figure: Preparing the external solar panel

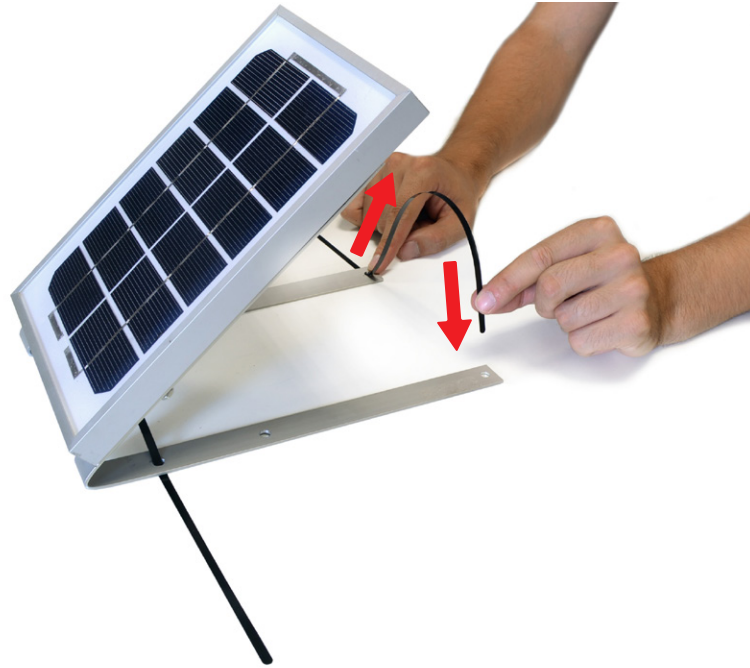

Figure: Adding cable ties to the external solar panel

Step 3: Secure Waspote Plug & Sense! to the street light

Place Waspote Plug & Sense! on street light tightening firmly the metal cable ties. Be sure that the node remains completely tied to street light to avoid it could fall down.



Figure: Placing Waspote Plug & Sense! on a street light

Step 4: Secure the external solar panel to the street light

It is recommended to place the external solar panel above Wasmote Wasmote Plug & Sense!, using it as a roof. This will increase protection against rain and sunlight. Use cable ties and the dedicated holes of the solar panel bracket to complete Wasmote Plug & Sense! installation.

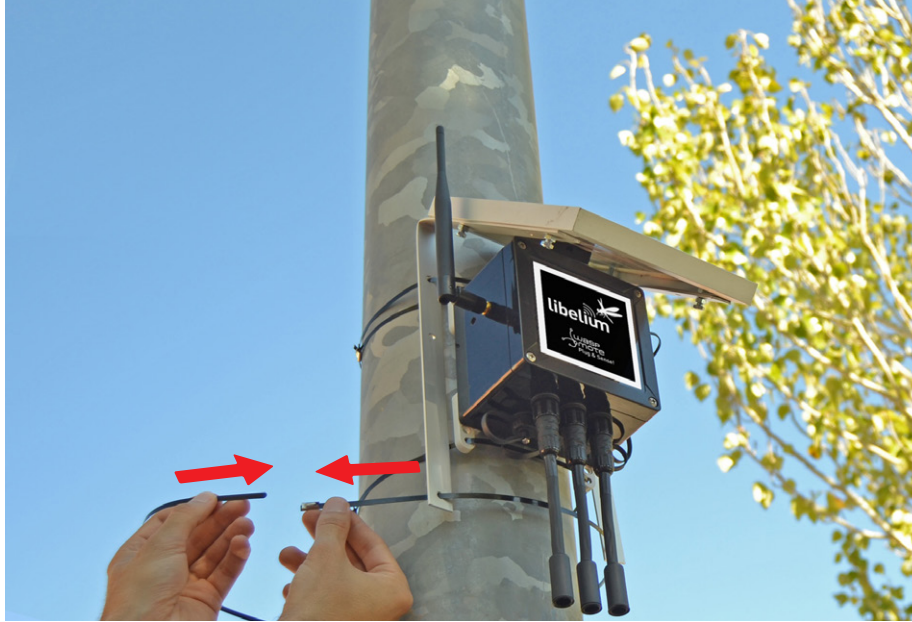

Figure: Placing external solar panel above Wasmote

29.3. Wall installation

Another typical installation of Waspote Plug & Sense! is on walls. Using the mounting feet accessory, the node can be tied using provided screws and wall plugs. Next pictures show examples of typical installation processes using the external solar panel in combination with provided accessories.

29.3.1. External solar panel

Step 1: Secure the solar panel bracket to the external solar panel

Use provided screws to secure the solar panel bracket to the external solar panel. Be sure you place screws in the right bracket holes, as shown in previous section.

Step 2: Secure Waspote Plug & Sense! to the wall.

Use provided screws and wall plugs to secure firmly the node to the wall. Check if the node remains completely fixed to avoid it could fall down.



Figure: Waspote Plug & Sense! placed on a wall

Step 3: Secure the external solar panel to a wall

It is recommended to place the external solar panel above the node, using it as a roof. This will increase protection against rain and sun. Use screws and the dedicated holes of the solar panel bracket to complete the installation.



Figure: Placing the external solar panel above Wasp mote

30. Energy Consumption

30.1. Consumption tables

Waspote

On	17 mA
Sleep	30 μ A
Deep Sleep	33 μ A

Waspote modules

	On	Sleep	Off	Sending	Receiving
XBee-PRO 802.15.4	56,68 mA	0,12 mA	0 μ A	187,58 mA	57,08 mA
XBee 868LP	60,82 mA	--	0 μ A	160 mA	73 mA
XBee-PRO 900HP	64,93 mA	0,93 mA	0 μ A	77 mA	66 mA
WiFi PRO	33 mA	4 μ A	0 μ A	38 mA	38 mA
4G					

Note: Before setting Waspote to a low-power consumption mode, it is always recommended to switch any communication module off.

30.2. Energy system

30.2.1. Concepts

Waspote has four operational modes:

- **On:** Normal operation mode. Consumption in this state is **17 mA**.
- **Sleep:** The main program is paused, the microcontroller passes to a latent state, from which it can be woken up by all asynchronous interruptions and by the synchronous interruption generated by the Watchdog. The duration interval of this state is from **32 ms to 8 s**. Consumption in this state is **30 μ A**.
- **Deep Sleep:** The main program pauses, the microcontroller passes to a latent state from which it can be woken up by all asynchronous interruptions and by the synchronous interruption triggered by the RTC. The interval of this cycle can be **from seconds to minutes, hours, days**. Consumption in this state is **33 μ A**.
- **Hibernate:** The main program stops, the microcontroller and all the Waspote modules are completely disconnected. The only way to reactivate the device is through the previously programmed alarm in the RTC (synchronous interrupt). The interval of this cycle can be **from seconds to minutes, hours, days**. Almost all devices are totally disconnected from the battery: only the RTC is powered through the battery, from which it consumes **7 μ A**.

	Consumption	Microcontroller	Cycle	Accepted interruptions
On	17 mA	On	-	All interruption sources
Sleep	30 μ A	On	Depends on INT source	All interruption sources
Deep Sleep	33 μ A	On	1 s - 31 days	All interruption sources (RTC always used)
Hibernate	7 μ A	Off	1 s - 31 days	Only RTC

On the other hand, each **module** (radio, sensor board, etc) might have up to several operation modes.

- **On:** Normal operation mode.
- **Sleep:** Some communication modules permit to set up sleep modes so as to save energy (depends on each module).
- **Off:** By using Wasmote's digital switches (controlled by the microcontroller), the module is switched off completely. This mode has been implemented by **Libelium** as an **independent layer of energy control**, so that it can reduce consumption to a minimum (**~7 μ A**) without relegating to techniques implemented by the manufacturer.

For complete information about interruption types and their handling, see the "Interruption" chapter.

Related API libraries: **WaspPWR.h**, **WaspPWR.cpp**

All information about the programming and operation of interruptions can be found in the [Interrupt Programming Guide](#).

All the documentation is located in the [Development section](#) in the Libelium website.

Note: *Before setting Wasmote to a low-power consumption mode, it is always recommended to switch any communication module off.*

30.2.2. Sleep mode

In this mode, the main program is paused, the microcontroller passes to a latent state, from which it can be woken by all asynchronous interruptions and by the synchronous interruption generated by the Watchdog. When the Watchdog Timer is set up, the duration interval can be programmed from **16 ms** to **8 s**. Consumption in this state is **30 µA**.

In this mode the microcontroller stops executing the main program. The program stack where all the variables and log values are stored keep their value, so when Waspote returns to on mode, the next instruction is executed and the variable values are maintained.

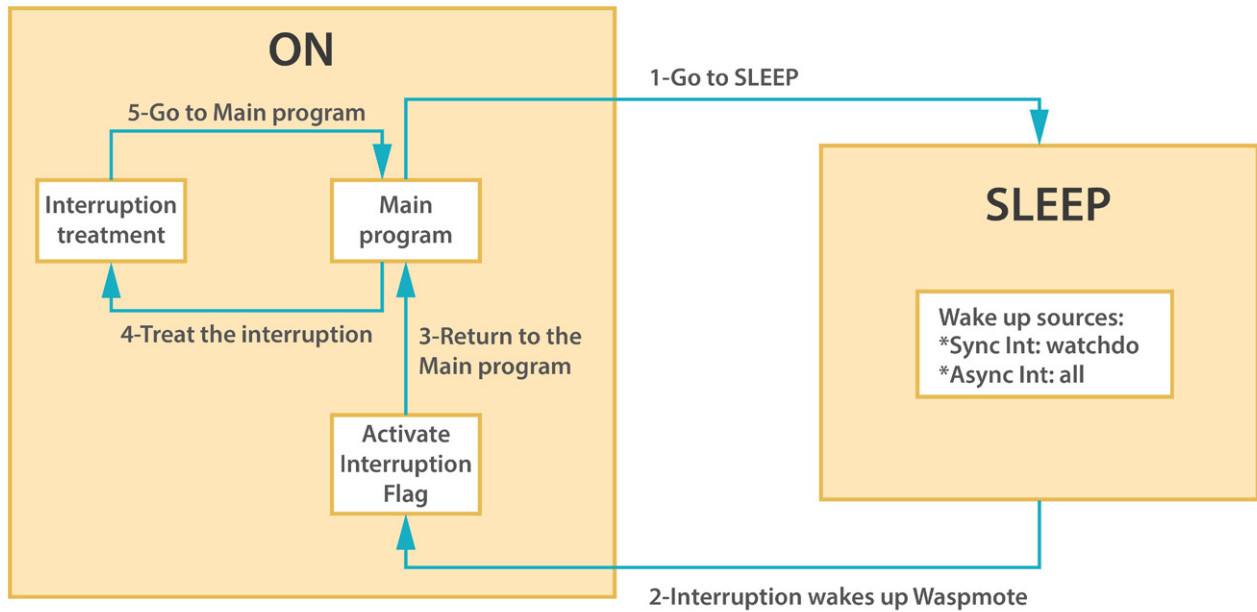

Figure: From on to Sleep mode

The following example would set Waspote in the Sleep mode for 32 ms. The microcontroller would be in a state of minimum consumption waiting for the synchronous interruption from the Watchdog:

```

{
  PWR.sleep(WTD_32MS, ALL_OFF);
}
  
```

30.2.3. Deep Sleep mode

In this mode, the main program is paused, the microcontroller passes to a latent state from which it can be woken by all the asynchronous interruptions and by the synchronous interruption launched by the RTC. The interval of this cycle can go **from seconds to minutes, hours, days**. Consumption in this state is **33 μ A**.

In this mode the microcontroller stops executing the main program. The program stack where all the variables and log values are stored keep their value, so when Wasp mote returns to on mode, the next instruction is executed and the variable values are maintained.

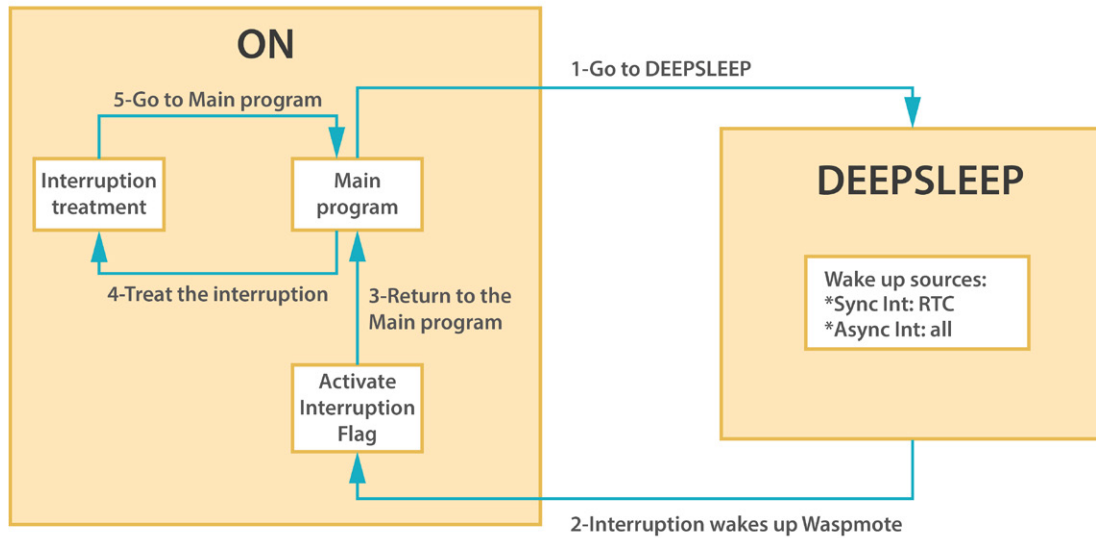

Figure: From on to Deep Sleep mode

30.3. Lifetime of the sensors

Libelium sensor probes are designed to increase lifetime of sensors when they are used outdoors. However, each sensor has a different lifetime depending on environmental conditions, usage and many other factors that Libelium cannot control.

It is suggested to use a solar shield with sensor probes which are going to be installed in places where sunlight is present. Besides, always use sensor probes following all recommendations given in this guide, to ensure the best lifetime.

The next table shows an appropriated lifetime of sensors which for physical limitations may expire:

Sensor probe type	Lifetime
Gas sensors	3 months – 2 years
Humidity and Temperature (Sensirion)	6 months – 2 years
Solar radiation	1 year – 2 years
Soil moisture	1 year – 2 years

Note: Gas sensors may require replacement for optimal accuracy.

Note: Some of sensor probes like Particle Matter, presence (PIR), ultrasound or solar radiation require a periodic maintenance due to dust and dirt and environment particles may affect to right measurements.

31. Recommendations

Libelium gives some recommendations to improve performance and efficiency of Waspote Plug & Sense!, enlarging the useful life of all of its elements:

- Try placing Waspote Plug & Sense! and its sensors out of the sun. It is known that sun rays accelerates plastic elements deterioration.
- Waspote Plug & Sense! is waterproof (rated at IP65). Avoid rain or water can reach the node directly when possible.
- If your model includes external solar panel, it is a good idea to place the node under the solar panel, to keep the node out of the rain, but ensuring solar panel is faced to south (north if you are on the south hemisphere) and tilted 45°.
- Always place the node under RF coverage of other Waspotes or Meshliums. It is a good idea to check RF communication before fixing the node to its final position.
- It is recommended to write down Waspote Plug & Sense! identification data of external sticker before placing it in its final place.
- Waspote Plug & Sense! is rated to IK07 against impacts. However, avoid any external object or machinery can impact with the node.
- Keep the node and its sensors out of range of people who can damage installation, wet sensors, etc.
- Temperature operating range is from -20 °C to 60 °C. Always ensure that the environment temperature is between these limits.
- Libelium takes no responsibility of any damage to third parties caused by a bad installation.

32. Documentation changelog

From v7.4 to v7.5

- Changed description of the new External SIM/USB Socket version, now nano-SIM compliant
- Changed specifications of the SD card, now 8 GB
- Deleted references to the discontinued Internal Solar Panel

From v7.3 to v7.4

- Added Programming Cloud Service section

From v7.2 to v7.3

- Added External Battery Module section
- Operating temperature range was updated
- Added notes about recharging the 6600 mA·h battery

From v7.1 to v7.2:

- Added references to the new GPS accessory for Plug & Sense!
- Added references to the discontinuation of Smart Environment
- Added references to the new sensors for Smart Environment PRO
- Deleted references to non-rechargeable batteries

From v7.0 to v7.1:

- Added references to the integration of Industrial Protocols for Plug & Sense!

33. Certifications

33.1. General overview

Products	Europe	US	Canada	Australia	Brazil
Plug & Sense! 802.15.4 EU	CE	-	-	-	-
Plug & Sense! 802.15.4	-	FCC	IC	RCM / CoC	CoC / Anatel
Plug & Sense! 868	CE	-	-	-	-
Plug & Sense! 900 US	-	FCC	IC	-	-
Plug & Sense! 900 AU	-	-	-	RCM / CoC	-
Plug & Sense! 900 BR	-	-	-	-	CoC / Anatel
Plug & Sense! 4G EU/BR	CE	-	-	-	CoC / Anatel
Plug & Sense! 4G US	-	FCC / PTCRB / AT&T	IC	-	-
Plug & Sense! 4G AU	-	-	-	RCM / CoC	-
Plug & Sense! WiFi	CE	FCC	IC	RCM / CoC	CoC / Anatel
Plug & Sense! Sigfox EU	CE	-	-	-	-
Plug & Sense! Sigfox US	-	FCC (in process)	IC (in process)	-	-
Plug & Sense! LoRaWAN EU	CE	-	-	-	-
Plug & Sense! LoRaWAN US	-	FCC	IC	-	-

33.2. CE (Europe)

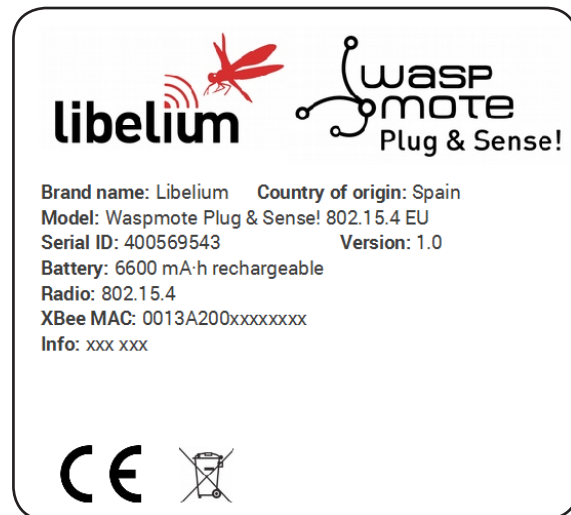

Figure: Back sticker for Waspote Plug & Sense! 802.15.4 EU

33.2.1. Wasmote Plug & Sense! 802.15.4 EU

Libelium Comunicaciones Distribuidas, S.L. declare under our sole responsibility that the product **Wasmote Plug & Sense! 802.15.4 EU** is in conformity with the essential requirements and other relevant requirements of the R&TTE Directive (1999/5/EC) and the 2002/95/CE Directive. The product is in conformity with the following standards and/or other normative documents:

- Health and Safety:
 - RoHS, EN 50581 (2012)
- Electro-Magnetic Compatibility:
 - EN 301 489-1 v1.9.2 (2011)
 - EN 301 489-17 v2.2.1 (2012)
 - EN 55022 (2010) / A1 (2011)
- Spectrum:
 - EN 300 328 v1.8.1 (2012-06)
- Electrical Security:
 - EN 60950-1 (2006) / A11 (2009) / A1 (2010) / A12 (2011) / Ac (2011) / A2 (2013) (except annex Zx)

33.2.2. Wasmote Plug & Sense! 868

The product Wasmote Plug & Sense! 868 is in conformity with the essential requirements and other relevant requirements of the R&TTE Directive (1999/5/EC) and the 2002/95/CE Directive. The product is in conformity with the following standards and/or other normative documents:

- Health and Safety:
 - EN 50581 (2012)
- Electro-Magnetic Compatibility:
 - EN 301 489-1 v1.9.2 (2011)
 - EN 301 489-3 v1.6.1 (2013)
 - EN 55022 (2010) / A1 (2011)
- Spectrum:
 - EN 300 220-2 v2.3.1 (2010-02)
- Electrical Security:
 - EN 60950-1 (2006) / A11 (2009) / A1 (2010) / A12 (2011) / Ac (2011) / A2 (2013) (except annex Zx)

33.2.3. Wasmote Plug & Sense! WiFi

The product Wasmote Plug & Sense! WiFi is in conformity with the essential requirements and other relevant requirements of the R&TTE Directive (1999/5/EC) and the 2002/95/CE Directive. The product is in conformity with the following standards and/or other normative documents:

- Health and Safety:
 - EN 50581 (2012)
- Electro-Magnetic Compatibility:
 - EN 301 489-1 v1.9.2 (2011)
 - EN 301 489-17 v2.2.1 (2012)
 - EN 55022 (2010) / A1 (2011)
- Spectrum:
 - EN 300 328 v1.8.1 (2012-06)
- Electrical Security:
 - EN 60950-1 (2006) / A11 (2009) / A1 (2010) / A12 (2011) / Ac (2011) / A2 (2013) (except annex Zx)

33.2.4. Wasmote Plug & Sense! 4G EU/BR

The product Wasmote Plug & Sense! 4G EU/BR is in conformity with the essential requirements and other relevant requirements of the R&TTE Directive (1999/5/EC) and the 2002/95/CE Directive. The product is in conformity with the following standards and/or other normative documents:

- Health and Safety:
 - RoHS, EN 50581 (2012)
- Electro-Magnetic Compatibility:
 - EN 301 489-24 v1.5.1 (2010-10)
 - EN 55022 (2010) / A1 (2011)
- Spectrum:
 - EN 300 440-2 v1.4.1 (2010-08)
 - EN 301 511 v9.0.2 (2002-11)
 - EN 301 908-1 v6.2.1 (2013-04)
 - EN 301 908-2 v6.2.1 (2013-10)
 - EN 301 908-13 v6.2.1 (2013-10)
- Electrical Security:
 - EN 60950-1 (2006) / A11 (2009) / A1 (2010) / A12 (2011) / Ac (2011) / A2 (2013) (except annex Zx)

33.2.5. Wasmote Plug & Sense! Sigfox EU

The product Wasmote Plug & Sense! Sigfox EU is in conformity with the essential requirements and other relevant requirements of the R&TTE Directive (1999/5/EC) and the 2002/95/CE Directive. The product is in conformity with the following standards and/or other normative documents:

- Health and Safety:
 - EN 50581 (2012)
- Electro-Magnetic Compatibility:
 - EN 301 489-1 v1.9.2 (2011)
 - EN 301 489-3 v1.6.1 (2013)
 - EN 55022 (2010) / A1 (2011)
- Spectrum:
 - EN 300 220-1 v.2.3.1 (2010)
 - EN 300 220-2 v.2.3.1 (2010)
- Electrical Security:
 - EN 60950-1 (2006) / A11 (2009) / A1 (2010) / A12 (2011) / Ac (2011) / A2 (2013) (except annex Zx)

33.2.6. Wasmote Plug & Sense! LoRaWAN EU

The product Wasmote Plug & Sense! LoRaWAN EU is in conformity with the essential requirements and other relevant requirements of the R&TTE Directive (1999/5/EC) and the 2002/95/CE Directive. The product is in conformity with the following standards and/or other normative documents:

- Health and Safety:
 - EN 50581 (2012)
- Electro-Magnetic Compatibility:
 - EN 301 489-1 v1.9.2 (2011)
 - EN 301 489-3 v1.6.1 (2013)
 - EN 55022 (2010) / A1 (2011)
- Spectrum:
 - EN 300 220-1 v.2.4.1 (2012-05)
 - EN 300 220-2 v.2.4.1 (2012-05)
- Electrical Security:
 - EN 60950-1 (2006) / A11 (2009) / A1 (2010) / A12 (2011) / Ac (2011) / A2 (2013) (except annex Zx)

33.3. FCC (USA)

This document applies to the following Waspote Plug & Sense! models:

Model	FCC ID
Waspote Plug & Sense! 802.15.4	XKM-WPS-2400-V1
Waspote Plug & Sense! 900 US	XKM-WPS-900-V1
Waspote Plug & Sense! WiFi	XKM-WPS-WIFI-V1
Waspote Plug & Sense! 4G US	XKM-WPS-4G-V1
Waspote Plug & Sense! LoRaWAN US	XKM-WPS-LORA-V1
Waspote Plug & Sense! Sigfox US	XKM-WPS-SFX-V1

Figure: Back sticker for Waspote Plug & Sense! 802.15.4











Brand name: Libelium **Country of origin:** Spain
Model: Waspote Plug & Sense! 802.15.4
Serial ID: 400569543 **Version:** 1.0
Battery: 6600 mA-h rechargeable
Radio: 802.15.4
XBee MAC: 0013A200xxxxxxx
Info: xxx xxx
FCC ID: XKM-WPS-2400-V1
IC: 8472A-WPS2400V1

This device complies with Part 15 of the FCC Rules. Operation is subject to the following two conditions: (1) this device may not cause harmful interference, and (2) this device must accept any interference received, including interference that may cause undesired operation.
Este equipamento opera em caráter secundário, isto é, não tem direito a proteção contra interferência prejudicial, mesmo de estações do mesmo tipo, e não pode causar interferência a sistemas operando em caráter primário.

HHHHH-FF-AAAAA

33.4. IC (Canada)

This document applies to the following Waspote Plug & Sense! Models:

Model	IC ID
Waspote Plug & Sense! 802.15.4	8472A-WPS2400V1
Waspote Plug & Sense! 900 US	8472A-WPS900V1
Waspote Plug & Sense! WiFi	8472A-WPSWIFIV1
Waspote Plug & Sense! 4G US	8472A-WPS4GV1
Waspote Plug & Sense! LoRaWAN US	8472A-WPSLORAV1

IC

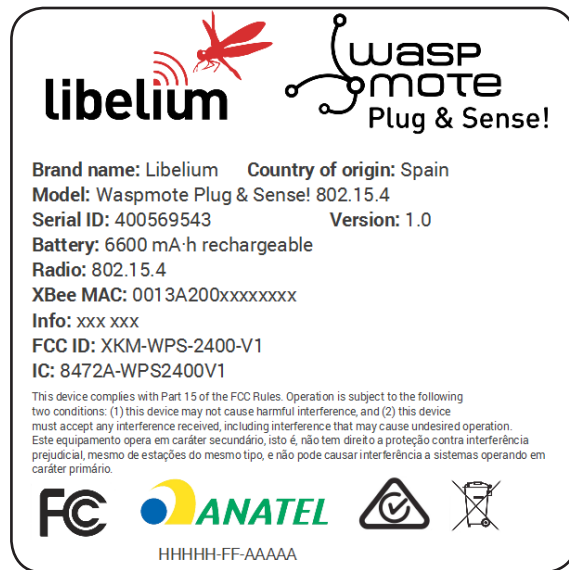

Figure: Back sticker for Waspote Plug & Sense! 802.15.4

33.5. ANATEL (Brazil)

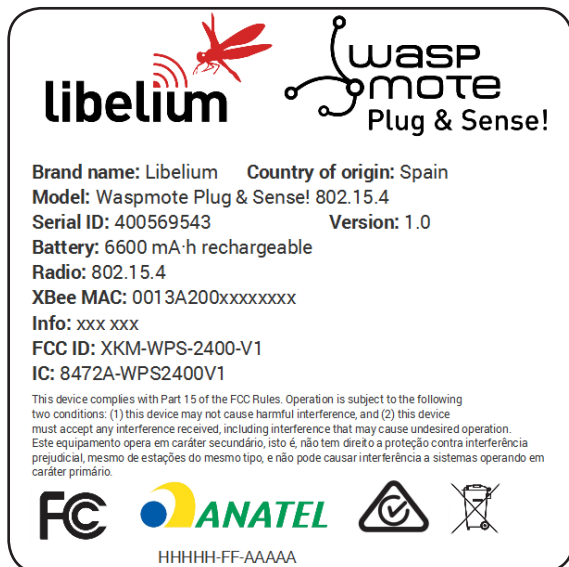



Figure: Back sticker for Waspote Plug & Sense! 802.15.4



33.6. RCM (Australia)



libelium  **wasp mote**
Plug & Sense!

Brand name: Libelium **Country of origin:** Spain
Model: Waspote Plug & Sense! 802.15.4
Serial ID: 400569543 **Version:** 1.0
Battery: 6600 mA·h rechargeable
Radio: 802.15.4
XBee MAC: 0013A200xxxxxxx
Info: xxx xxx
FCC ID: XKM-WPS-2400-V1
IC: 8472A-WPS2400V1

This device complies with Part 15 of the FCC Rules. Operation is subject to the following two conditions: (1) this device may not cause harmful interference, and (2) this device must accept any interference received, including interference that may cause undesired operation.
Este equipamento opera em caráter secundário, isto é, não tem direito a proteção contra interferência prejudicial, mesmo de estações do mesmo tipo, e não pode causar interferência a sistemas operando em caráter primário.

FC   

HHHHH-FF-AAAAA

Figure: Back sticker for Waspote Plug & Sense! 802.15.4

33.7. Use of equipment characteristics

Equipment to be located in an area of restricted access, where only expert appointed personnel can access and handle it.

The integration and configuration of extra modules, antennas and other accessories must also be carried out by expert personnel.

It is the responsibility of the installer to configure the different parameters of the equipment correctly, whether hardware or software, to comply with the pertinent regulation of each country in which it is going to be used.

Important: *It is the responsibility of the installer to find out about restrictions of use for frequency bands in each country and act in accordance with the given regulations. Libelium Comunicaciones Distribuidas S.L does not list the entire set of standards that must be met for each country. For further information go to:*

34. Maintenance

- Although Wasmote is a highly resistant product, please handle with care in order to enjoy a longer useful life.
- Handle Wasmote Plug & Sense! with care, do not allow it to drop or move roughly.
- Avoid placing the devices in areas reaching high temperatures that could damage the electronic components.
- The antennas screw on gently to the connector, do not force upon installing or you could damage the connectors.
- Plug antennas or sensor probes only in their corresponding connectors.
- Do not use any type of paint on the device, it could affect the operation of connections and closing mechanisms.
- Do not store Wasmote Plug & Sense! in places exposed to dirt and dust in order to avoid damage to electronic components.
- Never open the casing, warranty will not cover products that have been opened.
- For cleaning, use a damp cloth, no aggressive chemical products.

35. Disposal and recycling

- When Wasmote Plug & Sense! reaches the end of its useful life it must be taken to a recycling point for electronic equipment.
- The equipment should be disposed of separately from solid urban waste, please dispose of correctly.
- Your distributor will advise you on the most appropriate and environmentally-friendly way of disposing of the product and its packing.

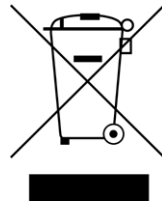

36. Resources

You can find complete information and support in the next sections in the Libelium Website:

- Development: <http://www.libelium.com/products/plug-sense/>
- Forum: <http://www.libelium.com/forum/>